

Attachment I

(Pictures of the EUT and Electrical Schemes)

1 PICTURES

Front view



Back view



Side View



Internal view of enclosure

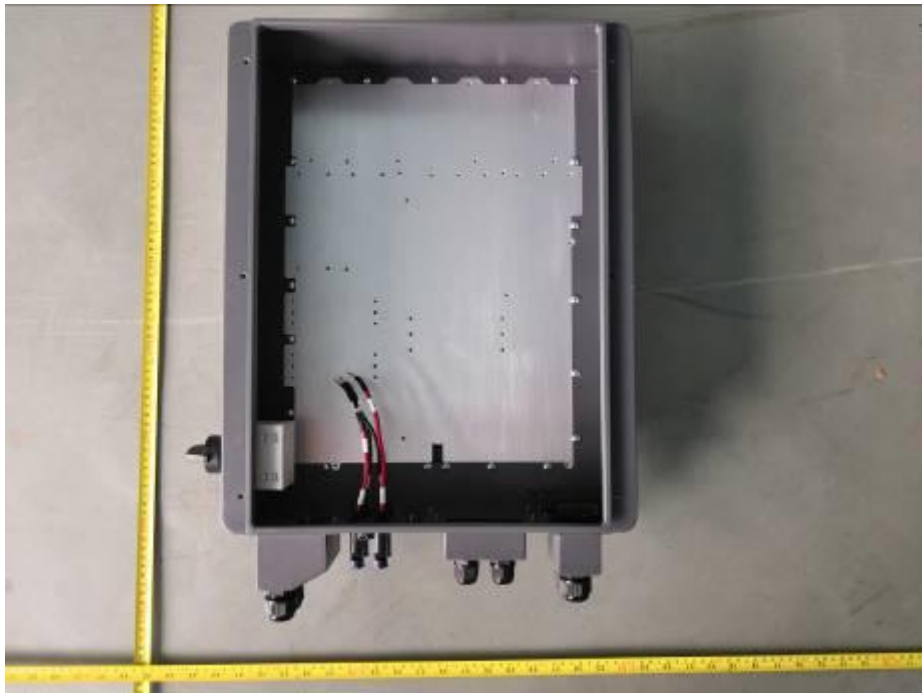

Top View



Internal View of Model HYD 5000-ES, HYD 6000-ES



Internal View of Model HYD 3000-ES, HYD 3600-ES, HYD 4000-ES



Grounding



AC Terninals

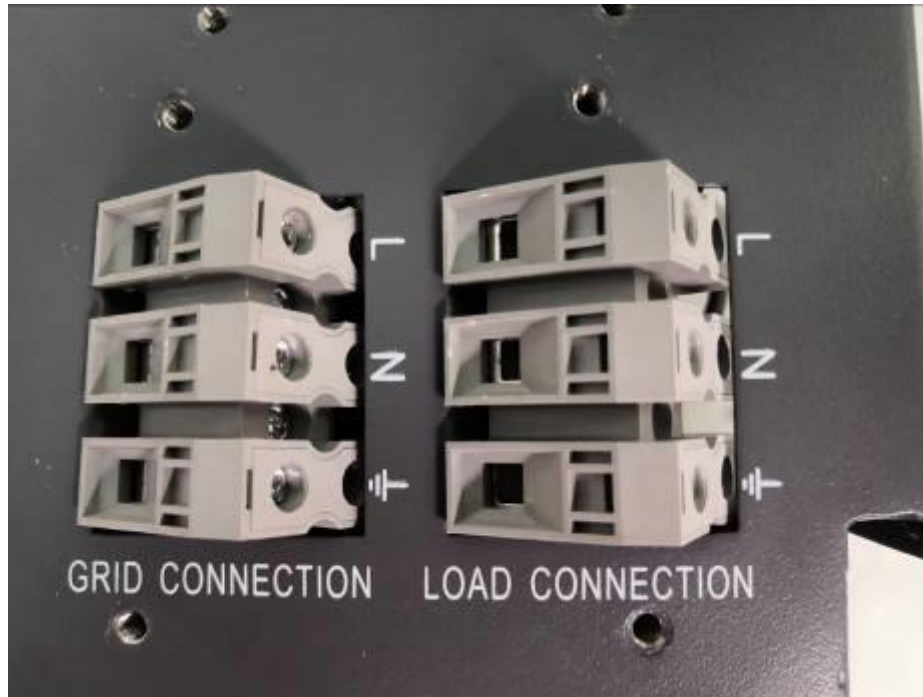

DC Terninals

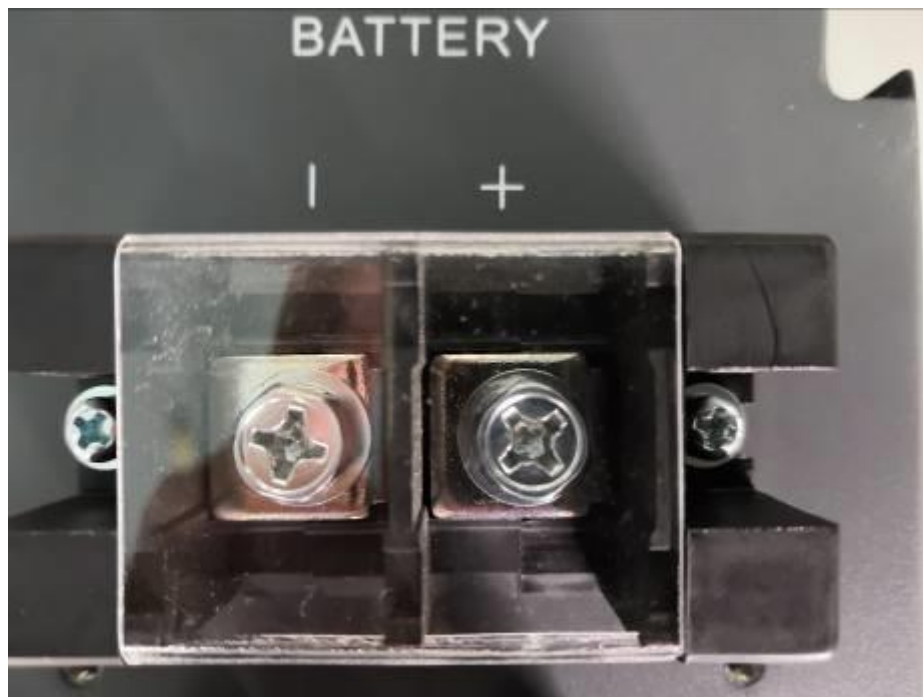

Front View of Power board



Back View of Power board

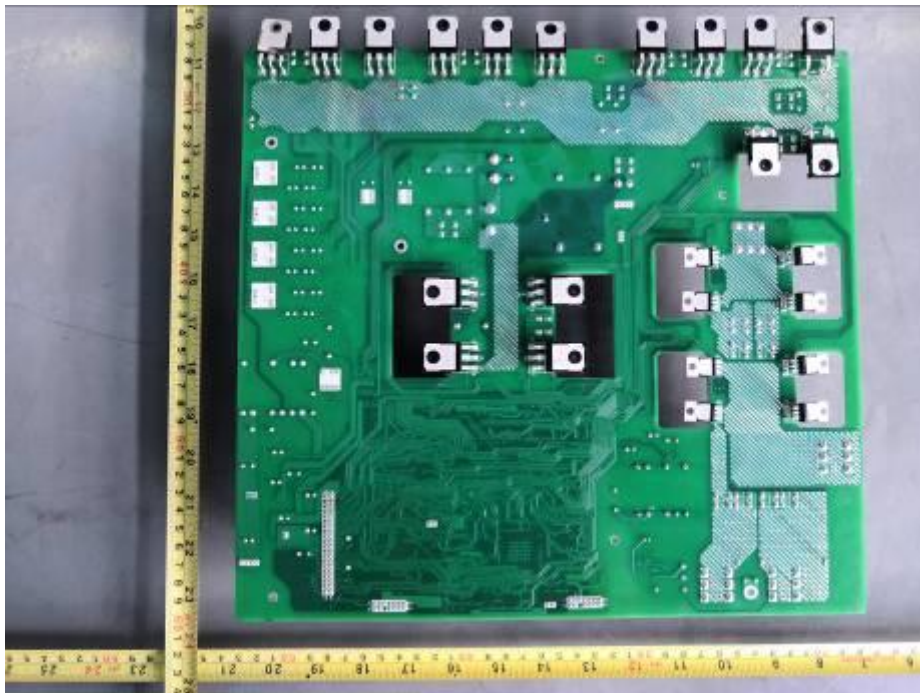

Front View of Input,output and communication board

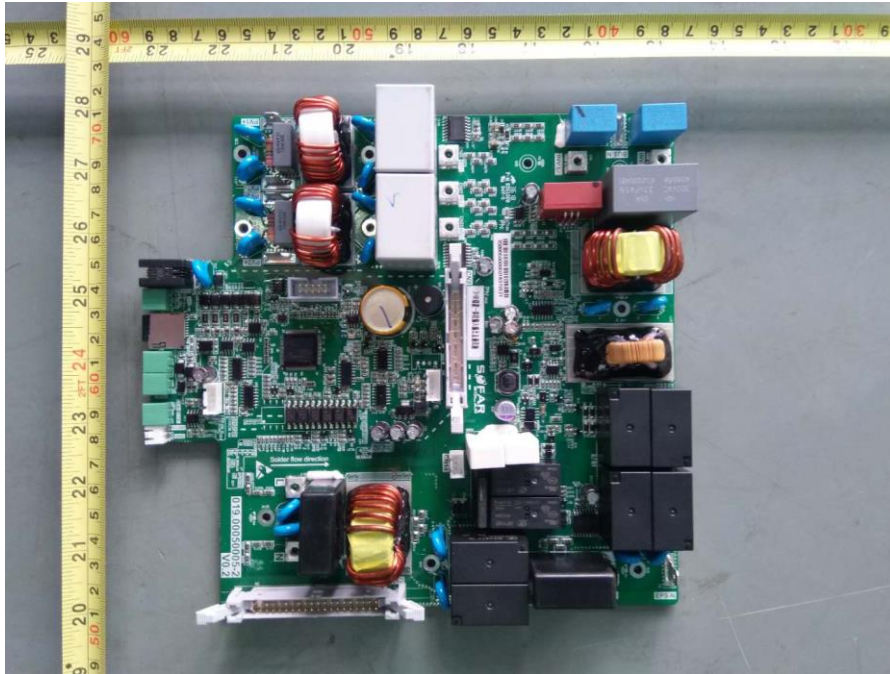

Back View of Input,output and communication board

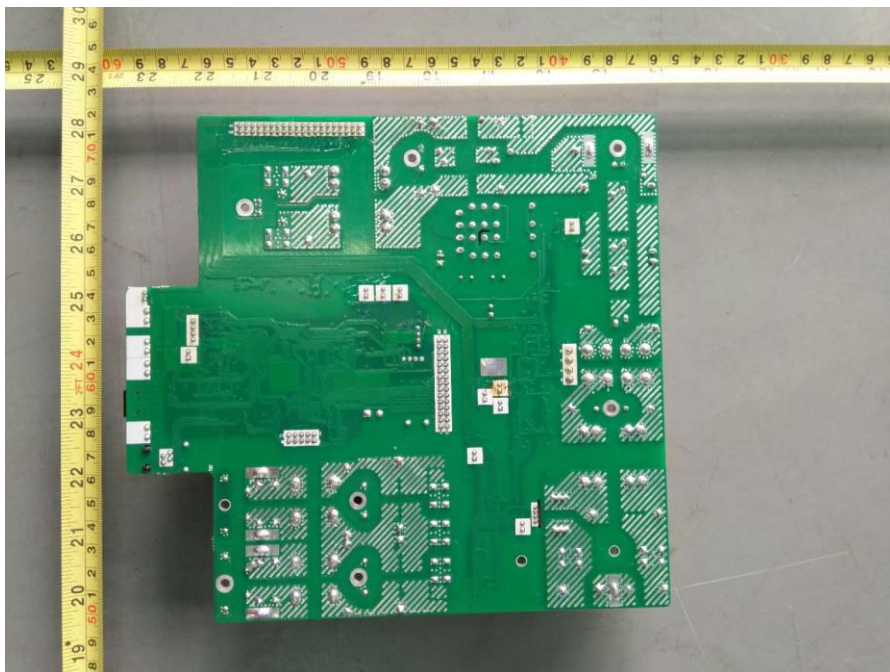

Front View of HYD 5000-ES, HYD 6000-ES Cap. board



Back View of HYD 5000-ES, HYD 6000-ES Cap. board

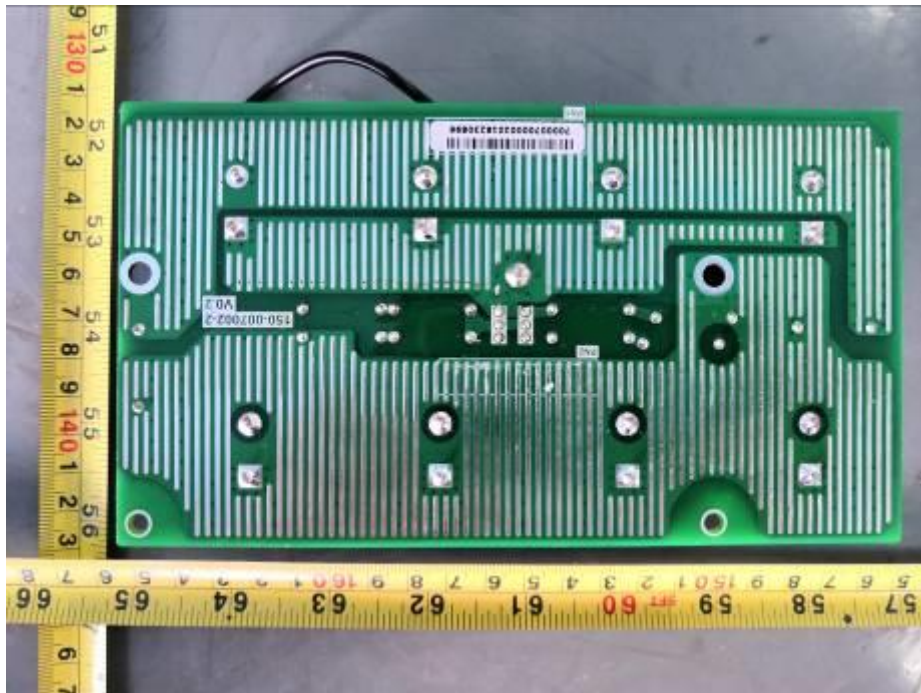

Front View of HYD 3000-ES, HYD 3600-ES, HYD 4000-ES Cap. board



Back View of HYD 3000-ES, HYD 3600-ES, HYD 4000-ES Cap. board

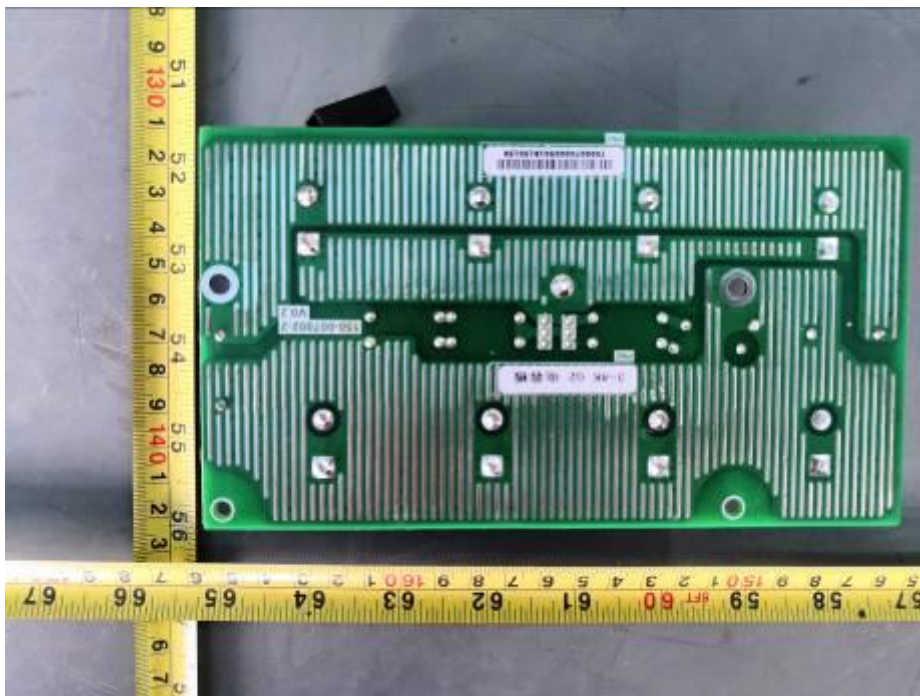

Front View of Cap board B



Back View of Cap board B

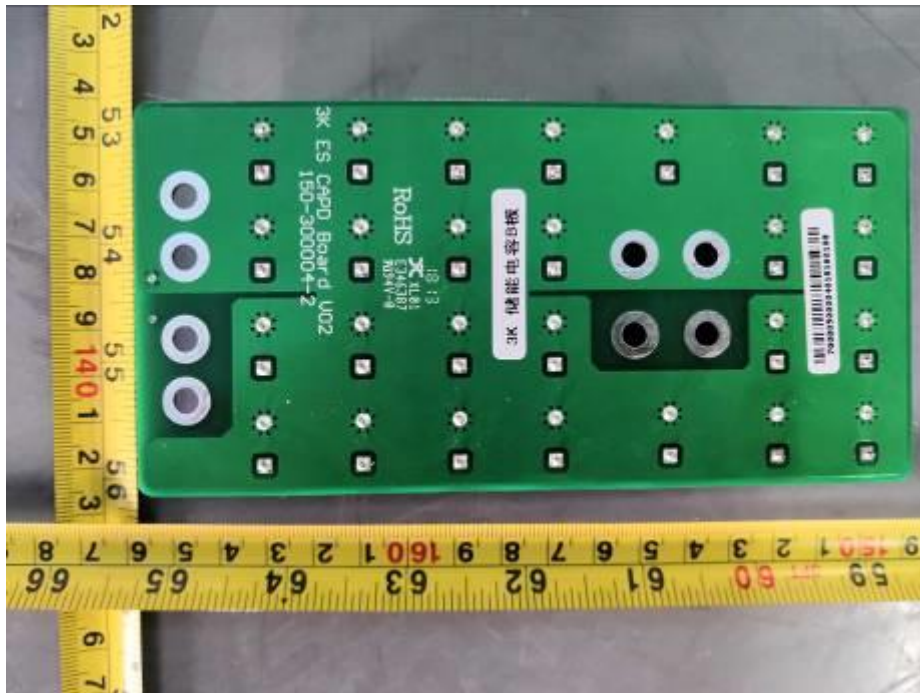

Front View of Cap board A

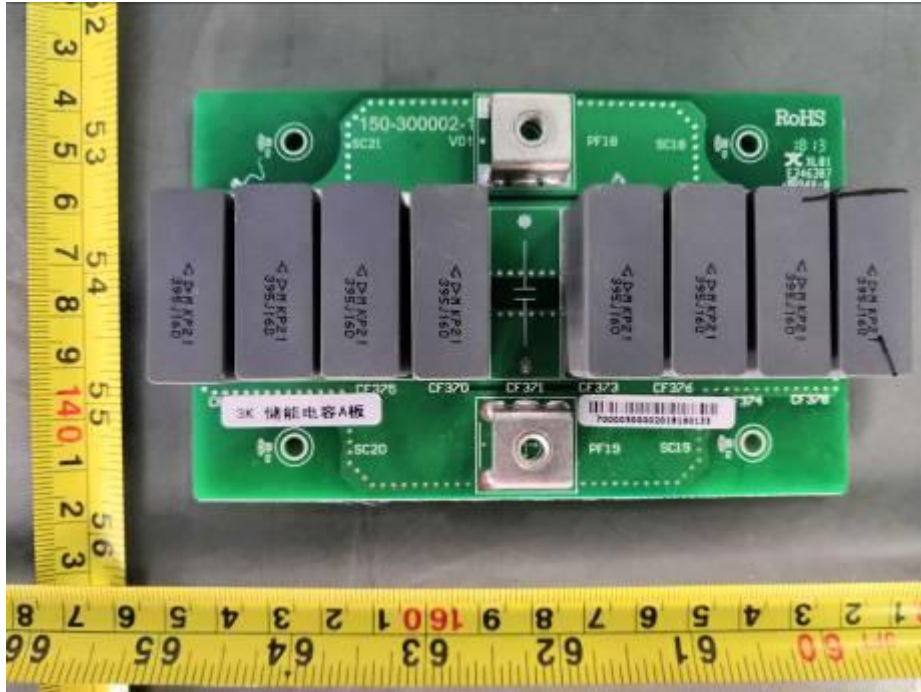

Back View of Cap board A

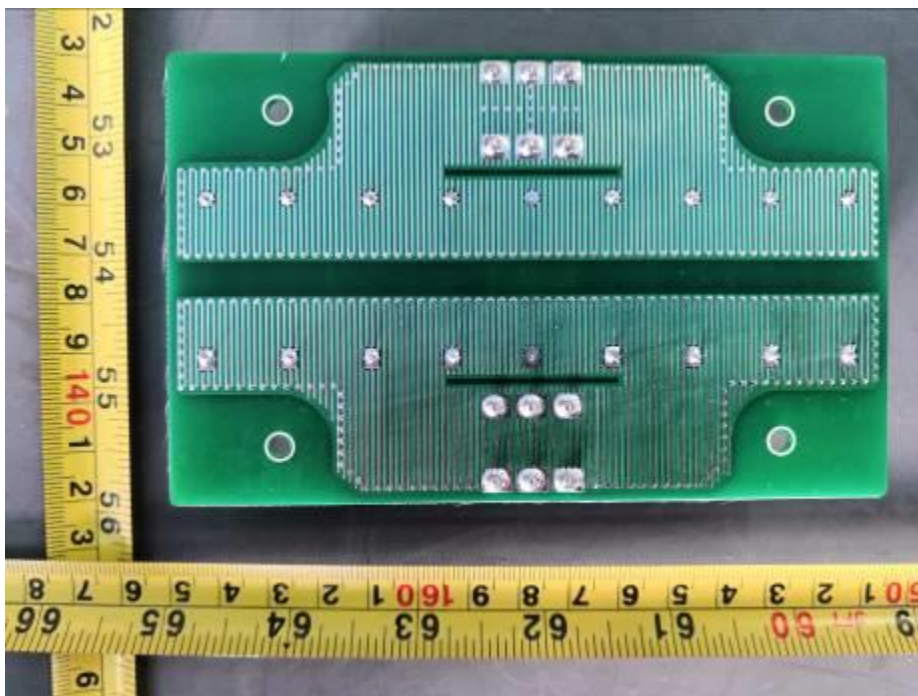

Front view of LED board



Back view of LED board

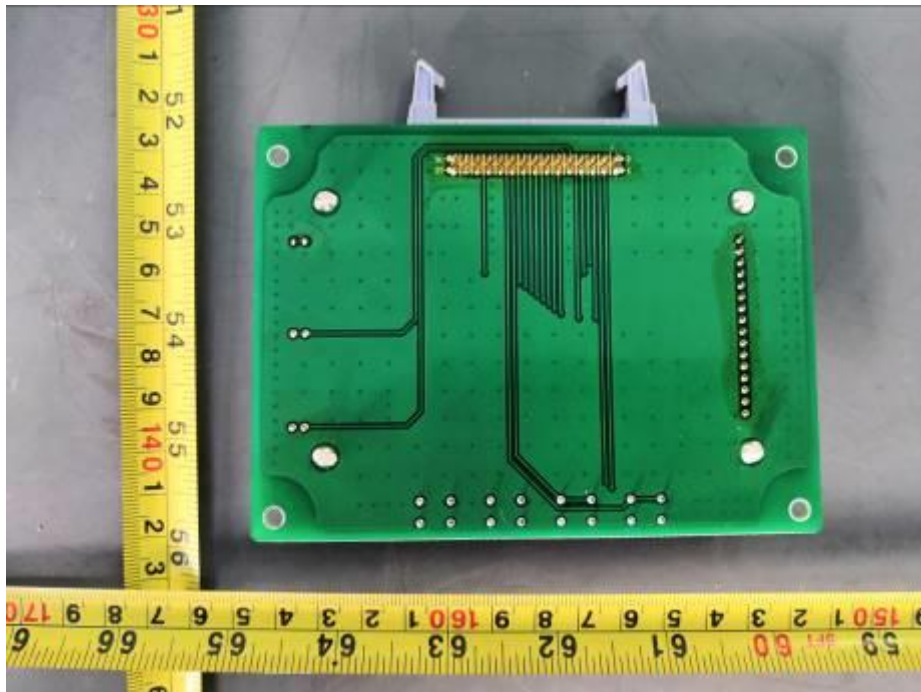

Front view of RS 232 board



Back view of RS 232 board



Serial Number and Software Version

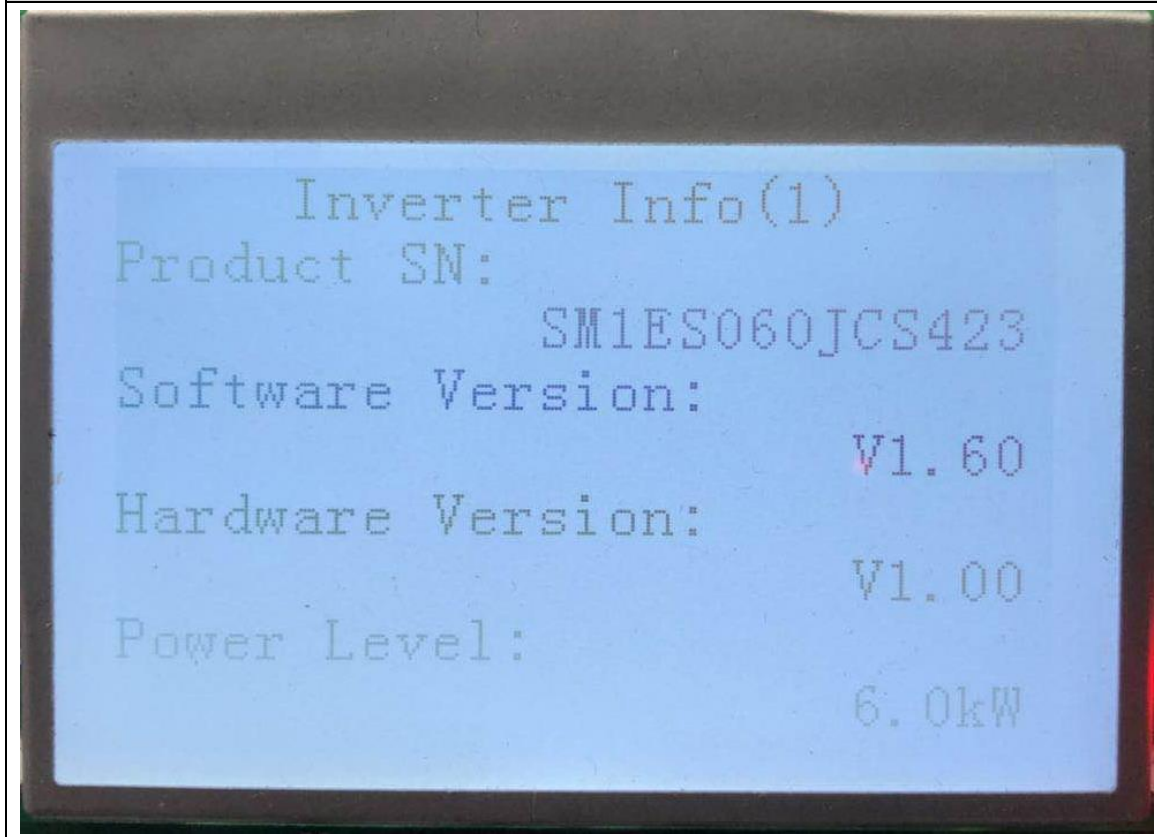

2 ELECTRICAL SCHEMES

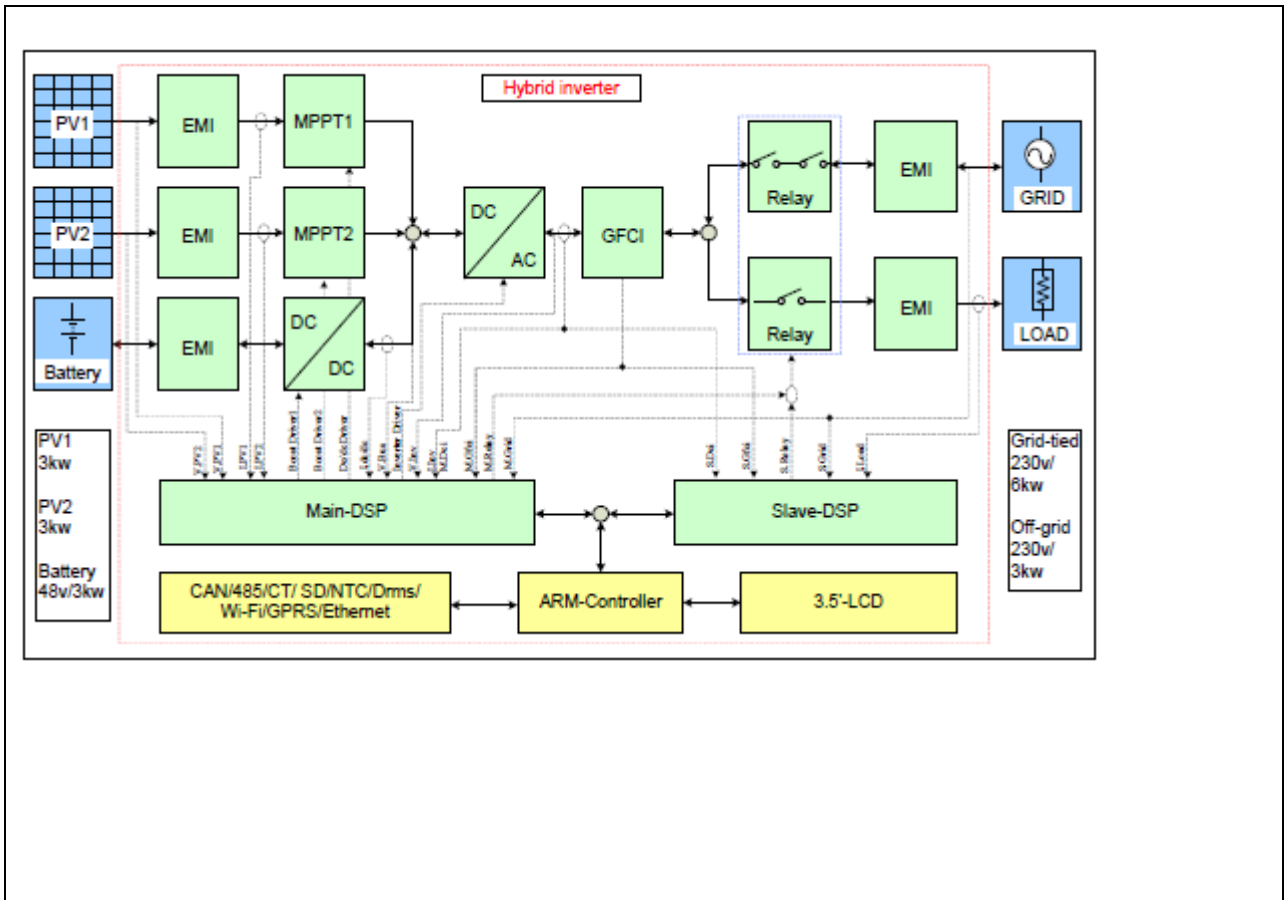

Attachment II

(Testing information)

1 TESTING CIRCUIT

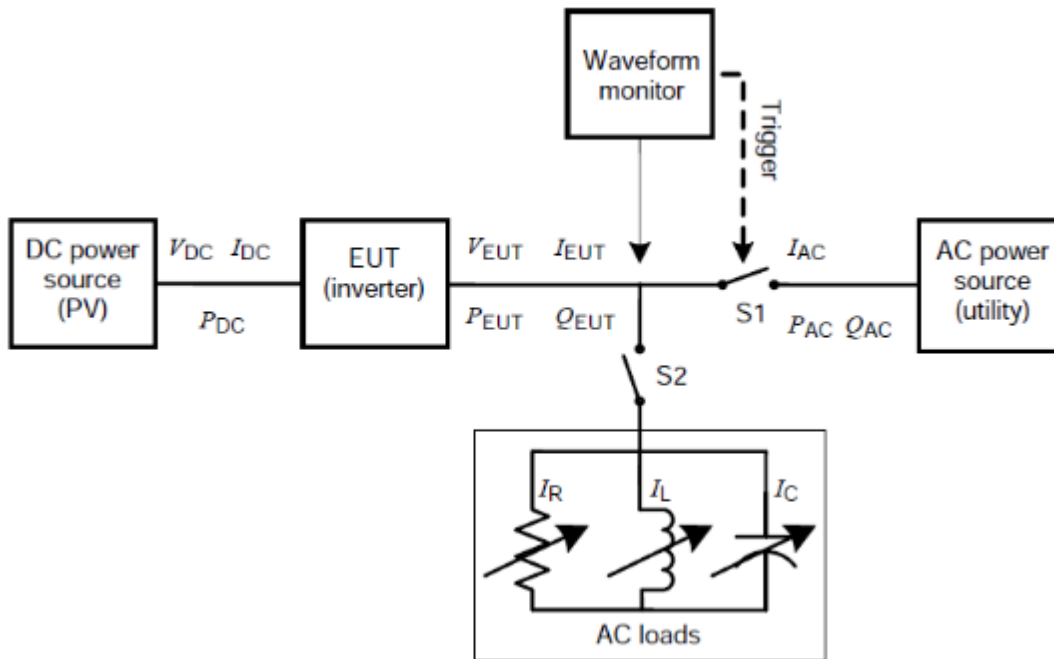

Current and voltage clamps have been connected to the inverter input/output for all the tests.
All the tests and checks have been performed in accordance with the reference standard under testing.

2 TESTING EQUIPMENT

From	No.	Equipment Name	MARK/Model No.	Equipment No.	Equipment calibration due date
Ba Lun	1	Current clamp	CT6863-05	BZ-EP-L006	2020/2/27
	2	Current clamp	CT6863-05	BZ-EP-L007	2020/2/27
	3	Digital oscilloscope	MS04054B	BZ-EP-L016	2020/2/25
	4	Power analyzer	PW6001-16	BZ-EP-L005	2020/2/26
	5	Power analyzer	PA6006H	BZ-EP-L051	2019/11/04
	6	Differential probe	DP6130	BZ-SFT-L061	2019/11/04
	7	Temperature & Humidity meter	DT-322	BZ-DGD-L005	2020/03/08
	8	Temperature & Humidity Chamber	8m3	BZ-KKX-L018	2019/11/01
	9	AC source	KACM-75-33	BZ-EP-L001	--
	10	PV array simulator	WLPA-150KW	BZ-DGD-L013	--
	11	RLC load	ACLT-38160H	BZ-DGD-L003	--
SGS	12	True RMS Multimeter	Fluke / 289C	GZE012-53	2020/02/26

Items	Specifications
1) PV array simulator	
a) Voltage range	0 – 1000Vdc (0.01V step)
b) Current range	0 – 40A (0.01A step)
2) AC power source	
a) Output wiring	Three phase
b) Output capacity	30KVA
c) Output voltage	10-300Vrms
d) Output frequency	45-65Hz
e) Voltage stability	± 100ppm/°C
f) Output voltage distortion	0.05% max.
3) Digital meter	
a) Voltage range	0 – 1000Vdc, 0 – 600Vrms
b) Current range	0 – 30A
c) Frequency range (accuracy)	0.2%
d) Measurement items	Voltage (V) Current (A) Active power (W) Reactive power (Var) Volt-ampere (VA) Power factor (PF) Frequency (Hz) Electric energy (Wh)
4) Waveform recorder	
a) Sampling speed	1M/s
b) Recording device	Memory record and USB reading
c) Time accuracy	± 500ppm
5) AC load	
a) Resistive load	Maximum voltage: 300Vrms Current range: 0 – 100A Capacity: 30KW
b) Inductive load	Maximum voltage: 300Vrms Current range: 0 – 100A Capacity: 30KVA
c) Capacitive load	Maximum voltage: 300Vrms Current range: 0 – 100A Capacity: 30KVA

3 MEASUREMENT UNCERTAINTY

Magnitude	Uncertainty
Voltage measurement	±1.5 %
Current measurement	±2.0 %
Frequency measurement	±0.2 %
Time measurement	±0.2 %
Power measurement	±2.5 %
Phase Angle	±1°
Temperature	±3° C
<p>Note1: Measurements uncertainties showed in this table are maximum allowable uncertainties. The measurement uncertainties associated with other parameters measured during the tests are in the laboratory at disposal of the petitioner.</p> <p>Note2: Where the standard requires lower uncertainties that those in this table. Most restrictive uncertainty has been considered.</p>	

Attachment III

(GRAPHS AND SCREENSHORTS OF TEST RESULTS)

Flickers

The measurements of voltage fluctuations have been measured at 33 %, 66% and 100 % of the nominal power value of the inverter.

As it can be seen in the next screenshots, this test has two steps:

- 1.Starting operation
- 2.Stopping operation

The values took of Dmax of the two steps.

Starting operation and Stopping operation

33% Pn

No.	dc[%]	dmax[%]	d(t)[ms]	Pst	Pit
Limit	3.30	6.00	500 3.30%	1.00	0.65 N:2
No. 1	0.161 Pass	0.328 Pass	0.0 Pass	0.199 Pass	
2	-0.149 Pass	1.307 Pass	0.0 Pass	0.325 Pass	
Result	Pass	Pass	Pass	Pass	0.277 Pass

Update: 1728 Runtime: 1:15:38 2019-04-29 10:19:07

66% Pn

No.	dc[%]	dmax[%]	d(t)[ms]	Pst	Pit
Limit	3.30	6.00	500 3.30%	1.00	0.65 N:2
No. 1	0.168 Pass	-0.315 Pass	0.0 Pass	0.254 Pass	
2	0.344 Pass	3.312 Pass	10.0 Pass	0.456 Pass	
Result	Pass	Pass	Pass	Pass	0.382 Pass

Update: 987 Runtime: 0:50:56 2019-04-29 09:54:24



As it can be seen in the next screenshots is running operation. The values took of Pst and Plt are the most unfavorable of the twelve steps.



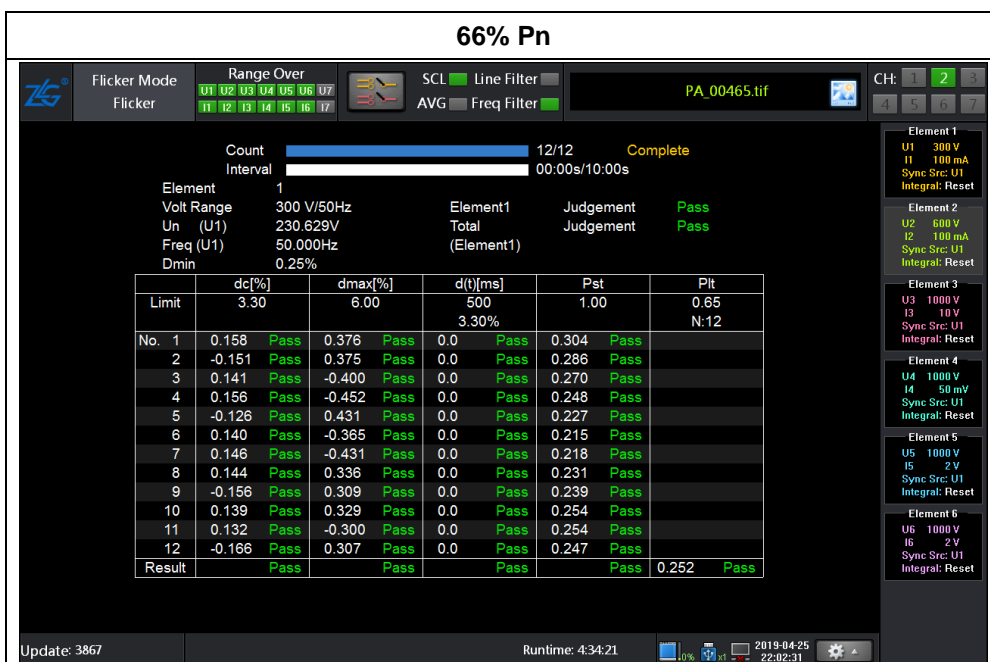

Direct current injection

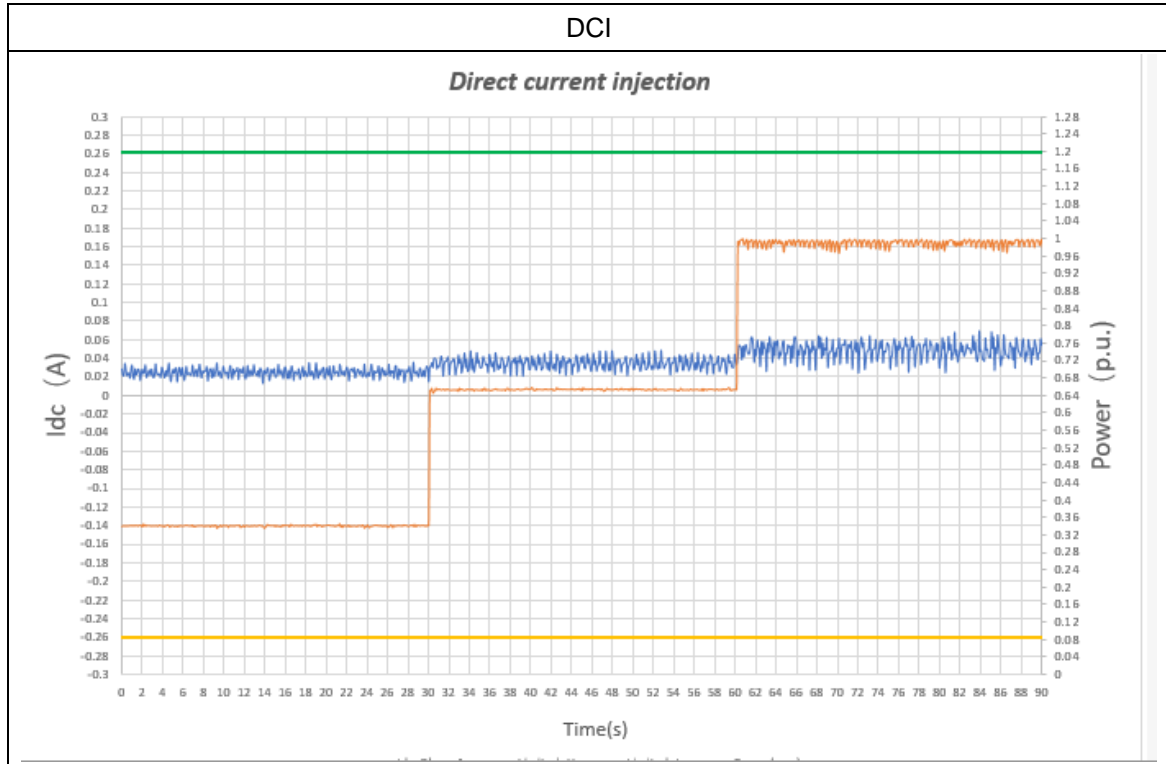

Harmonics and waveform distortion

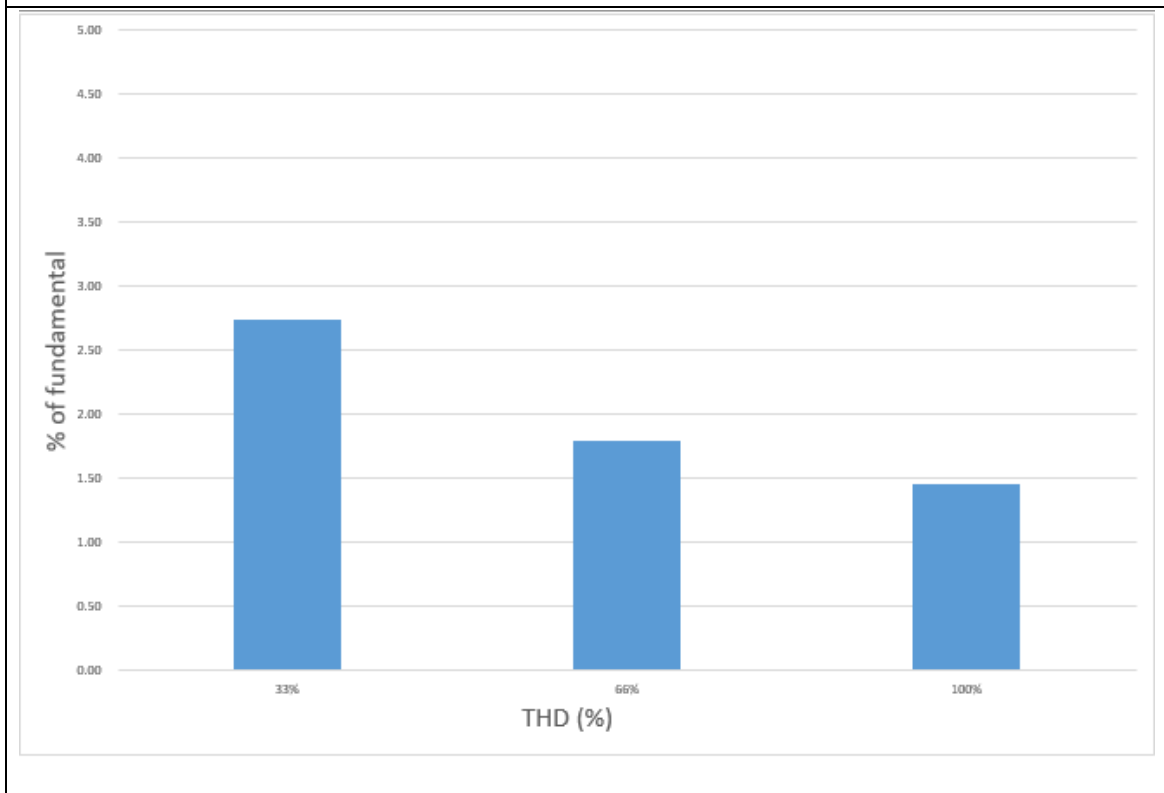
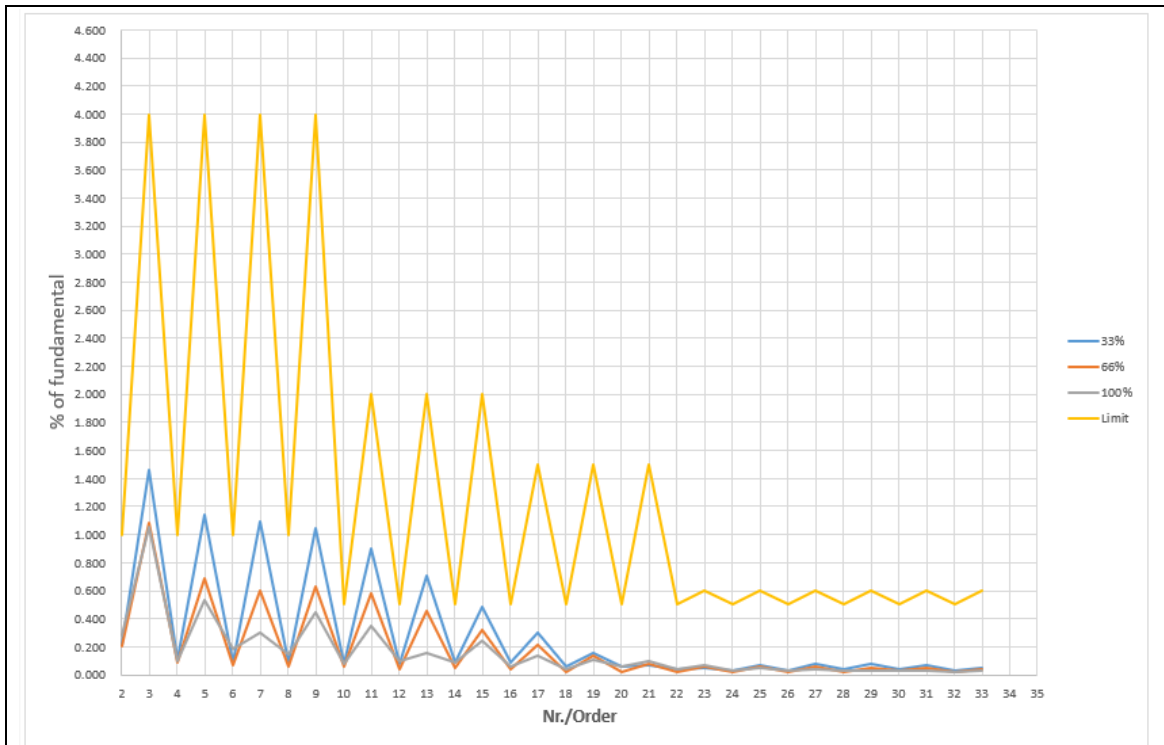

Power factor

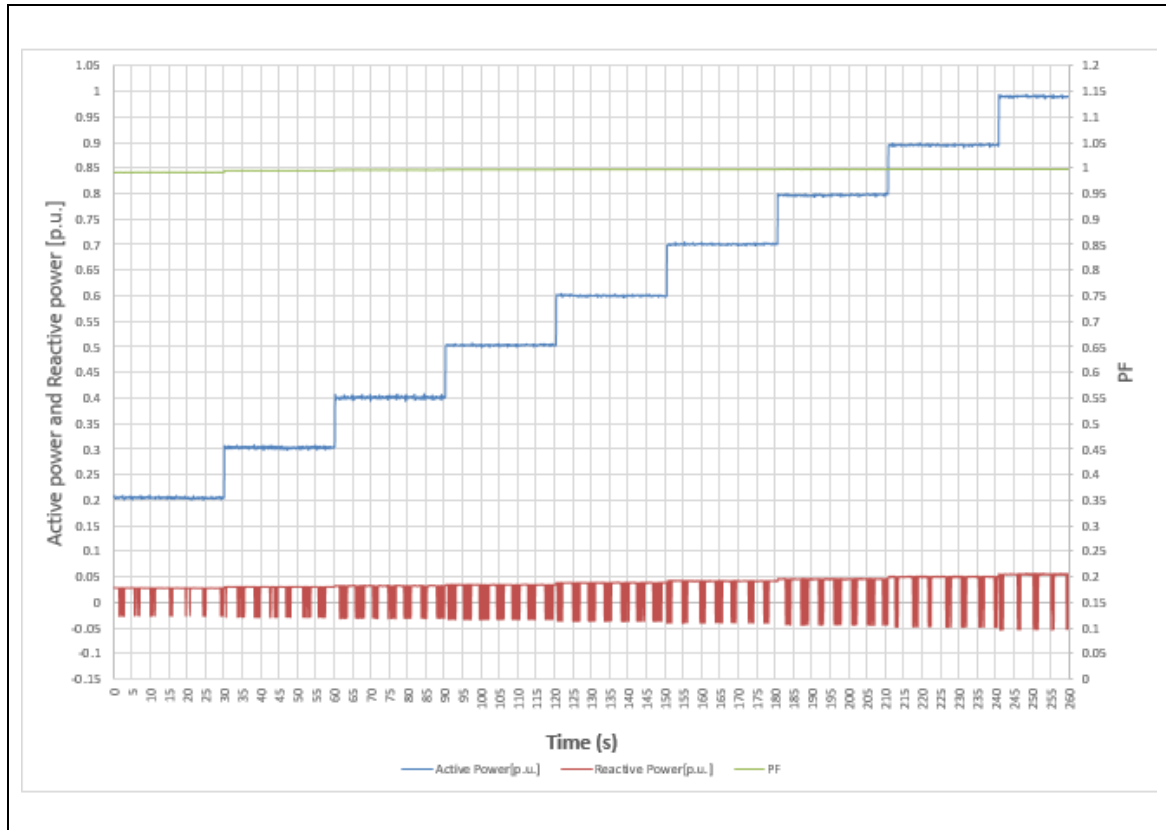

Under-and over-voltage trip settings and reconnection test

I

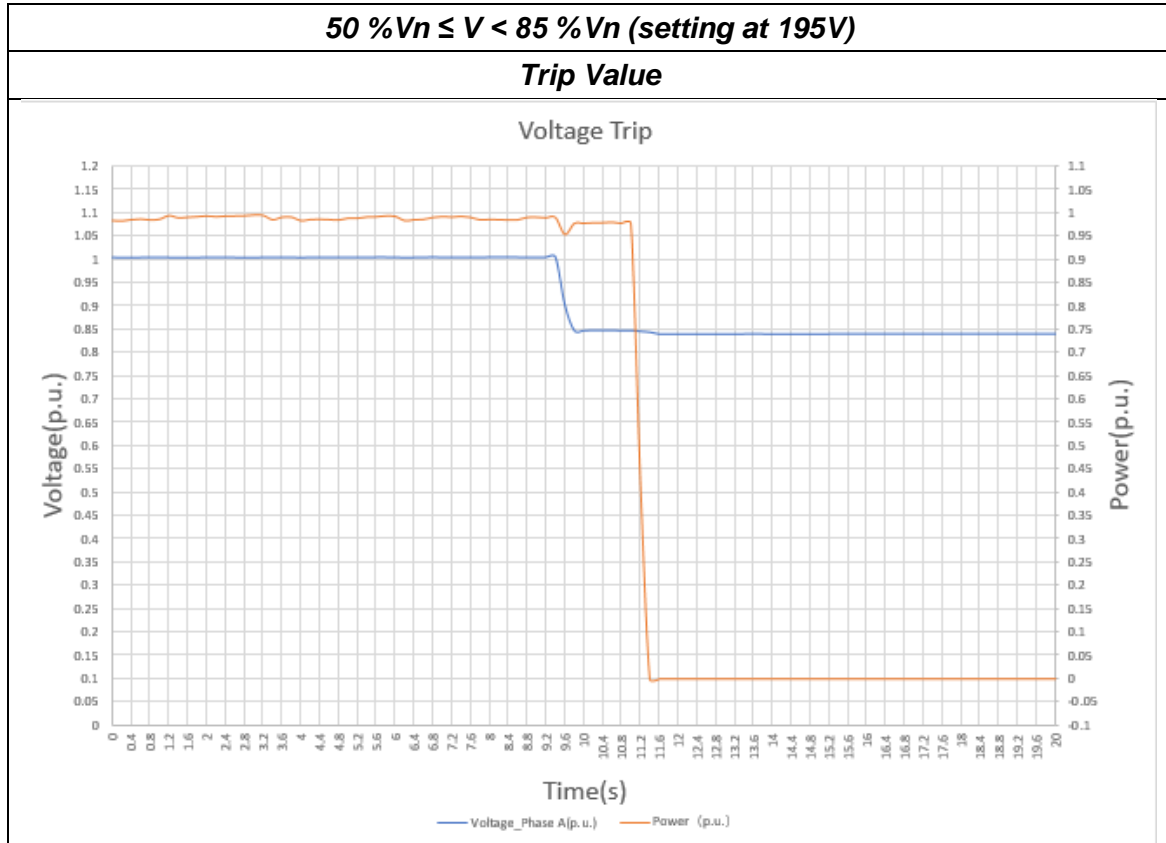

Disconnection Time

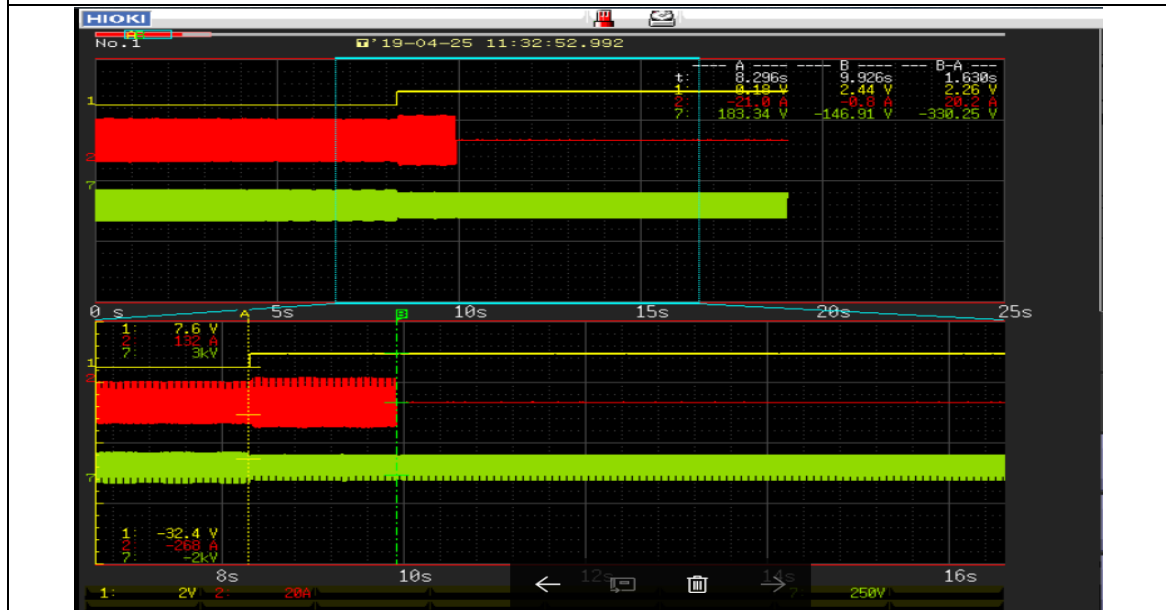

50 % ≤ V < 85 % (setting at 155V)

Trip Value

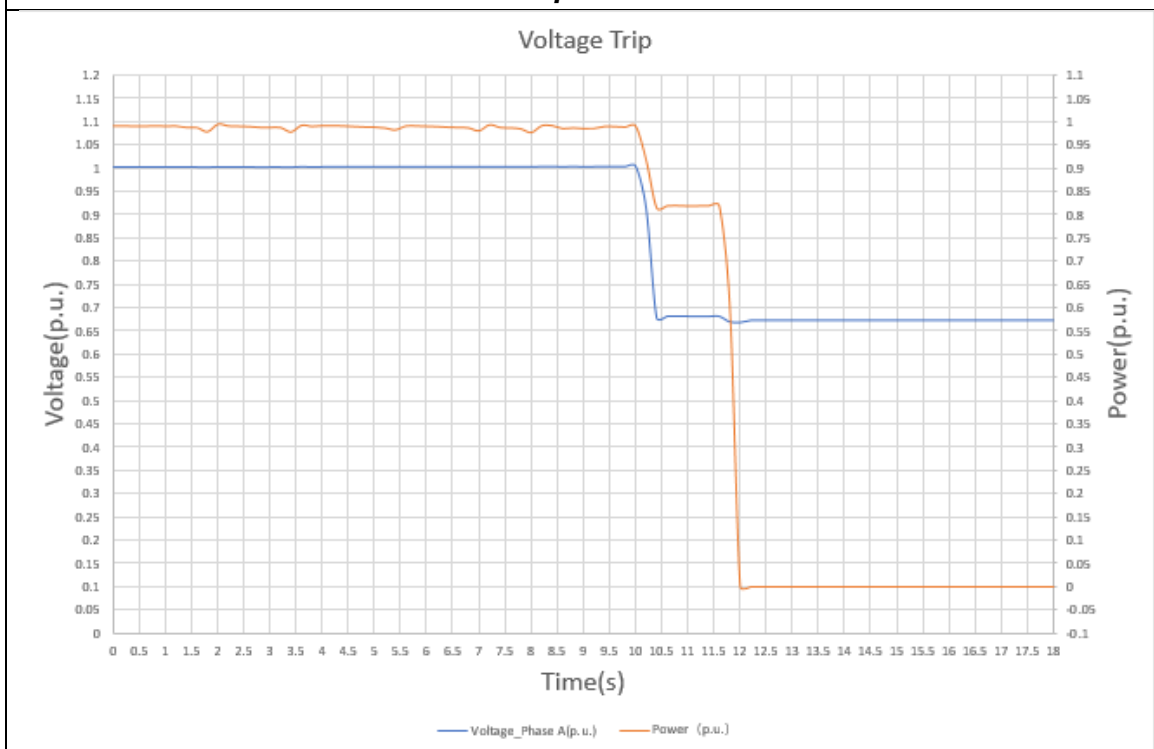

Disconnection Time

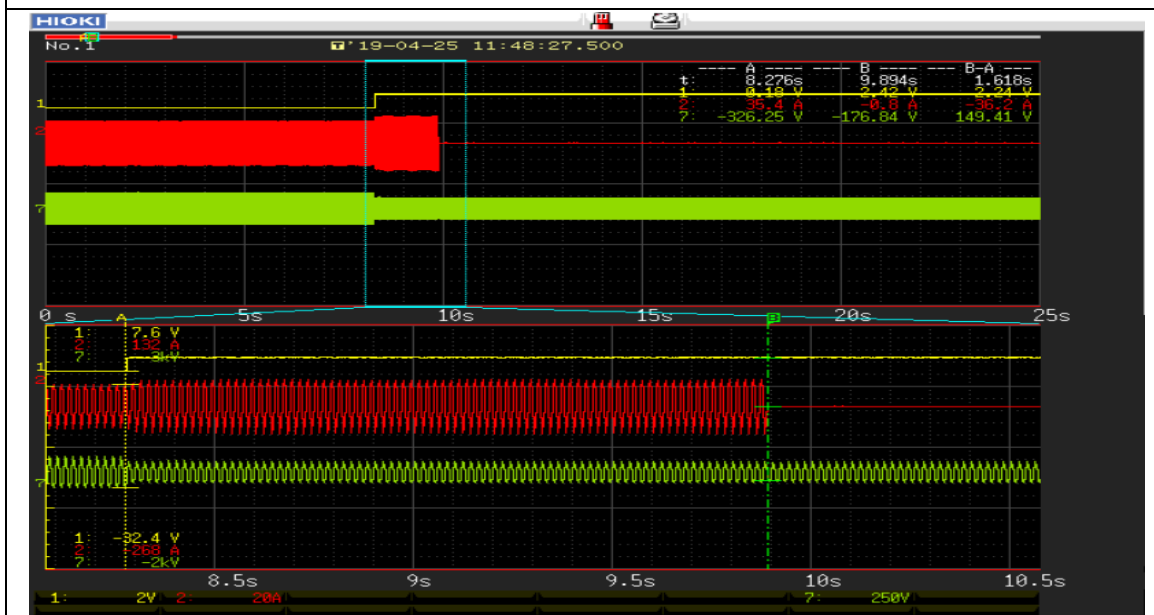

50 %Vn ≤ V < 85 %Vn (setting at 117V)

Trip Value

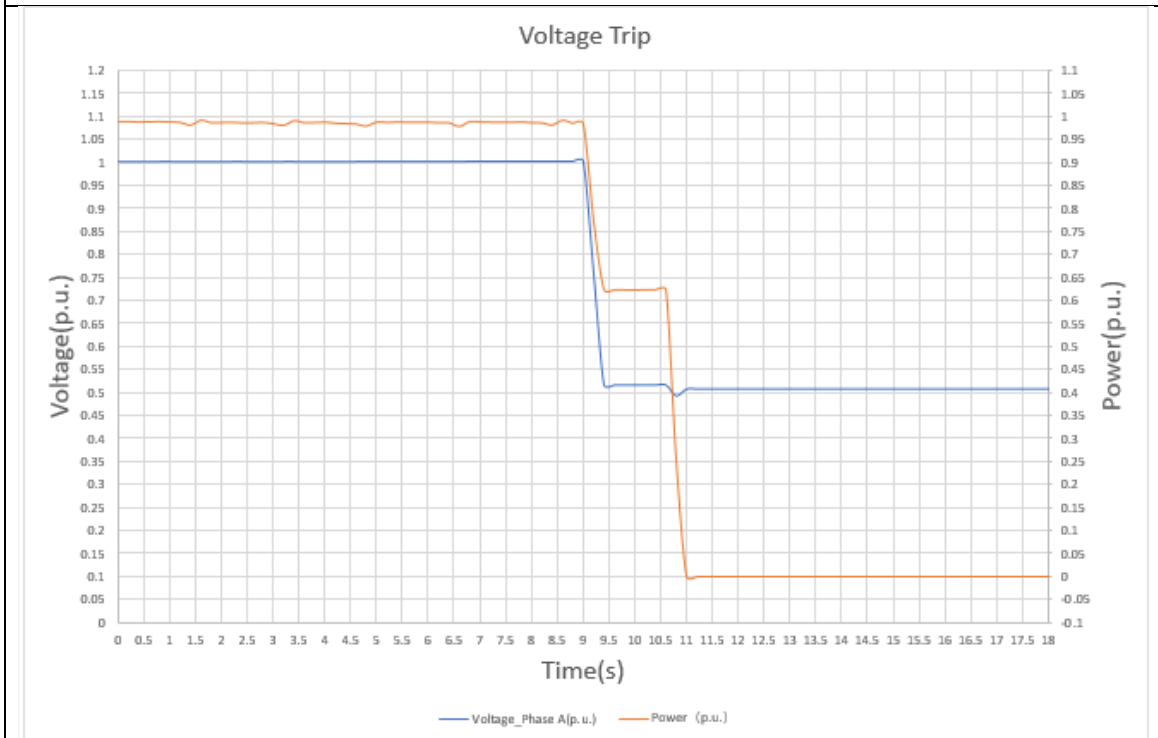

Disconnection Time



$V < 50\%V_n$

Trip Value

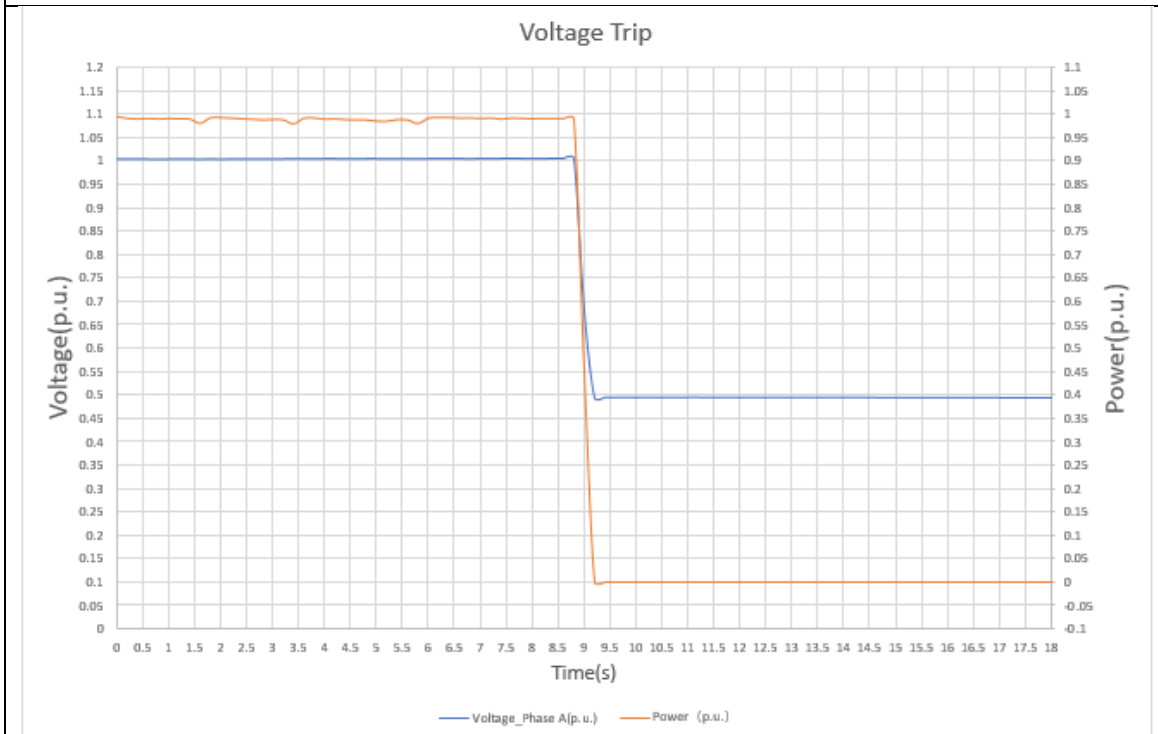

Disconnection Time

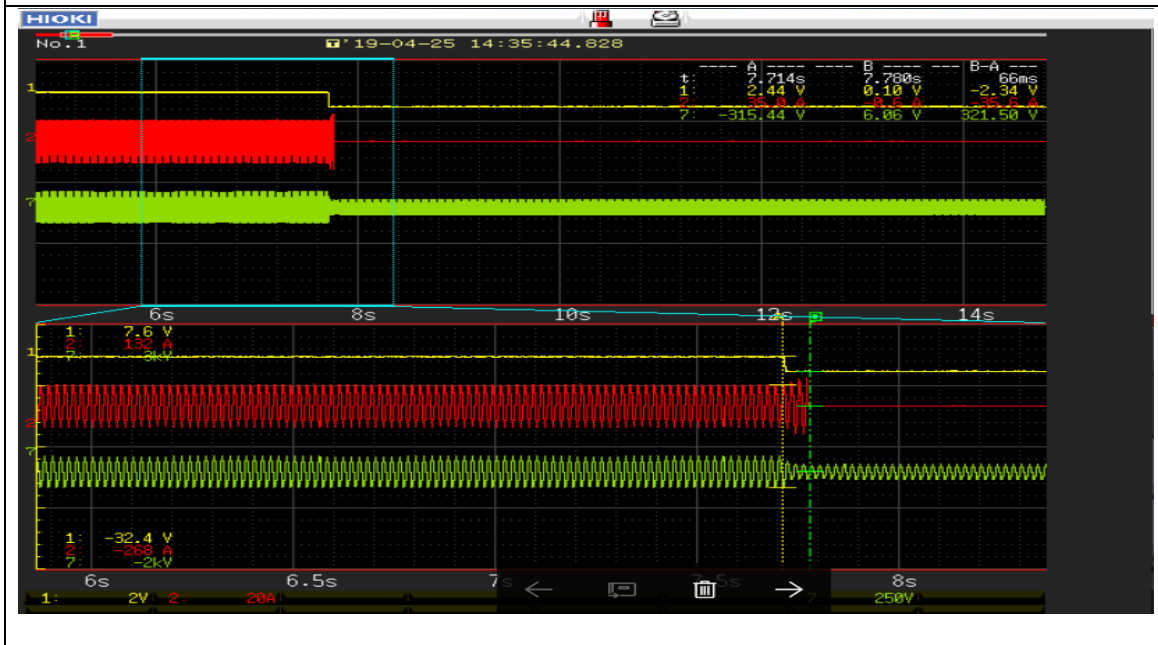

Under voltage Reconnection

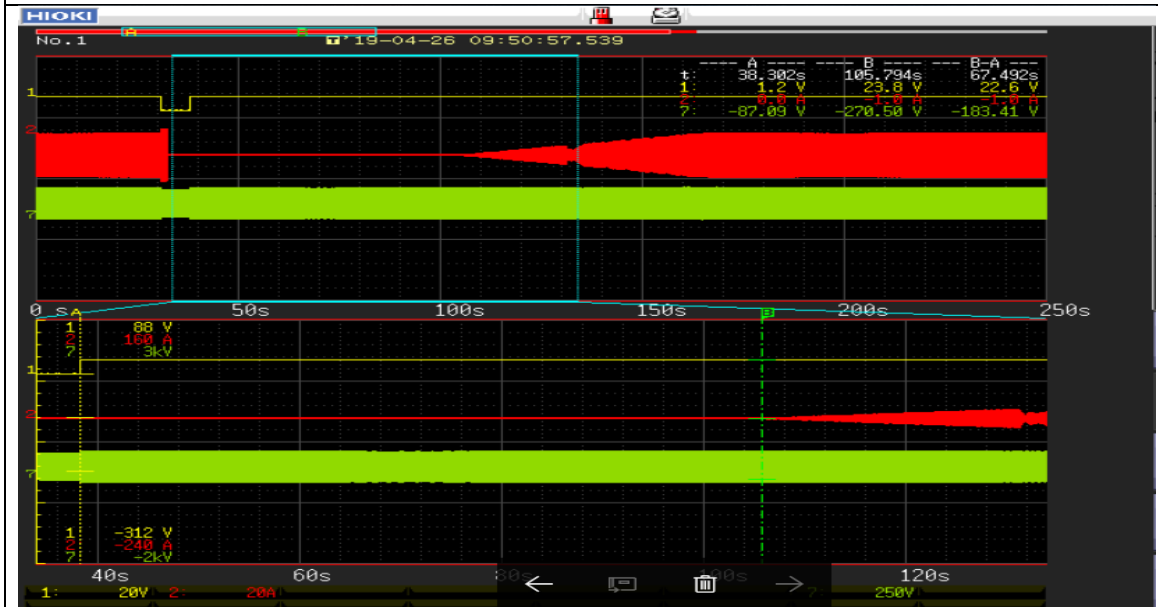
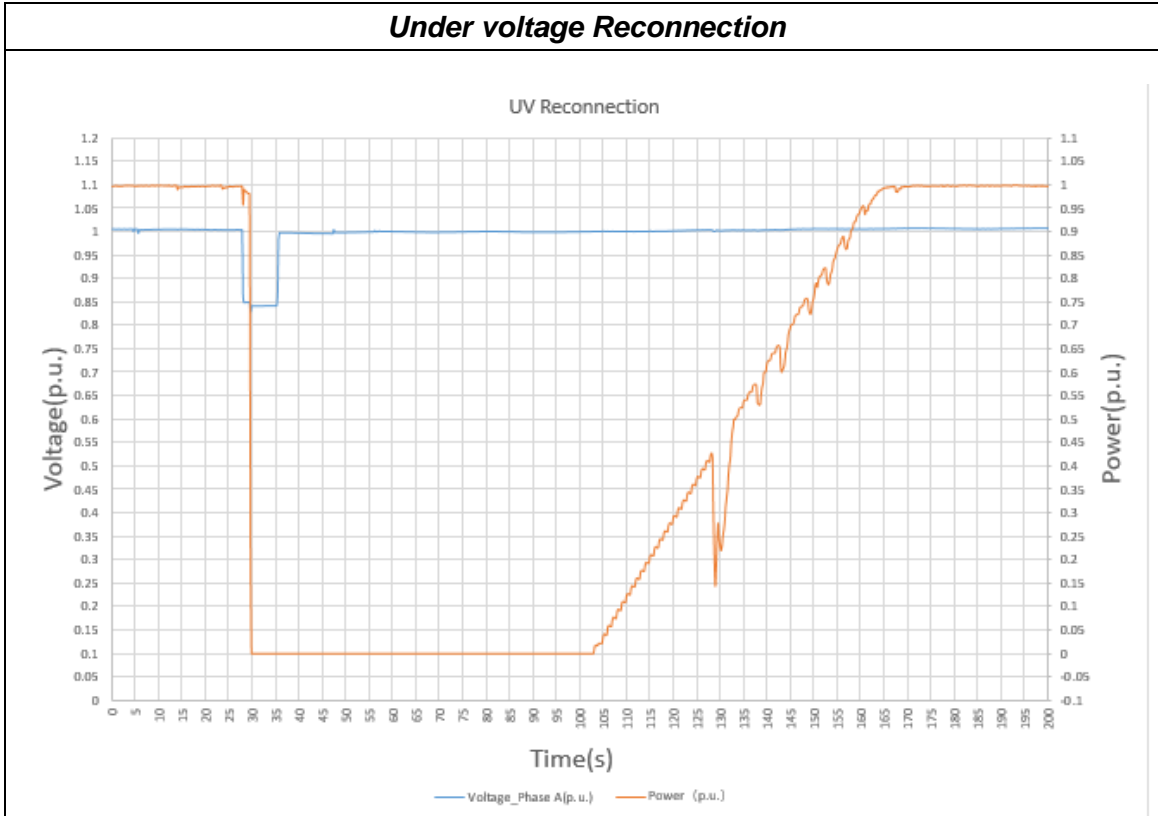

110 %Vn < V < 135 %Vn(setting at 255V)

Trip value

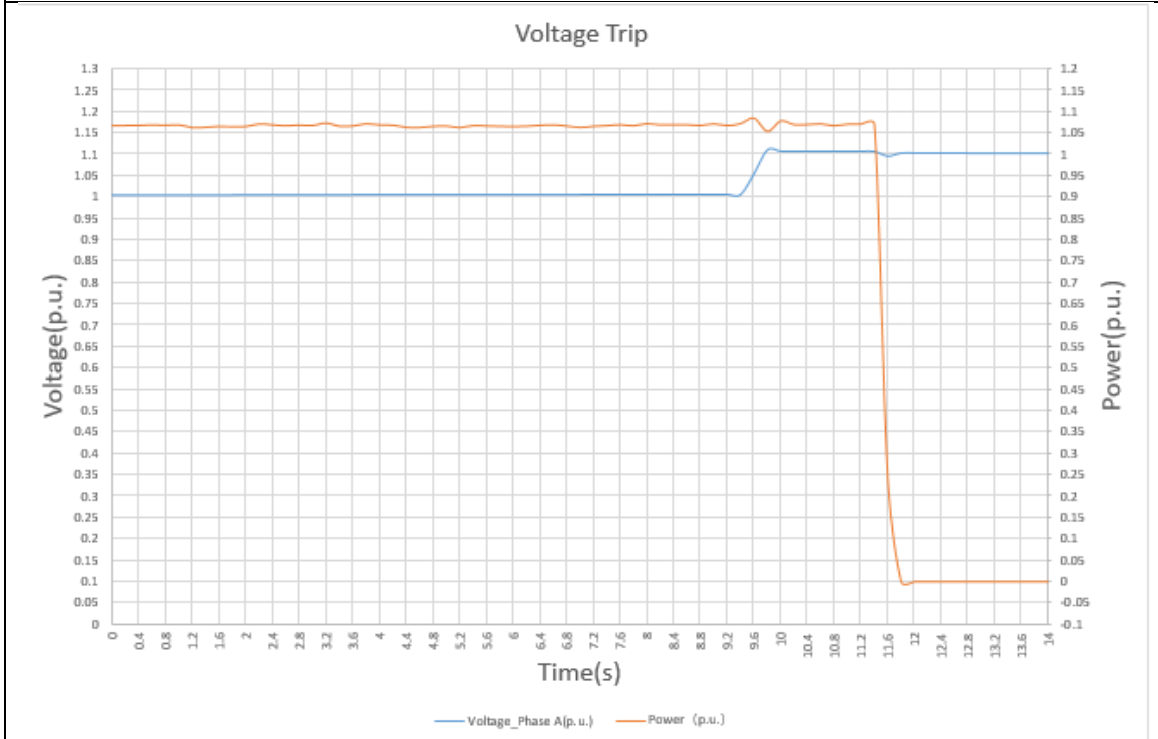

Disconnection Time

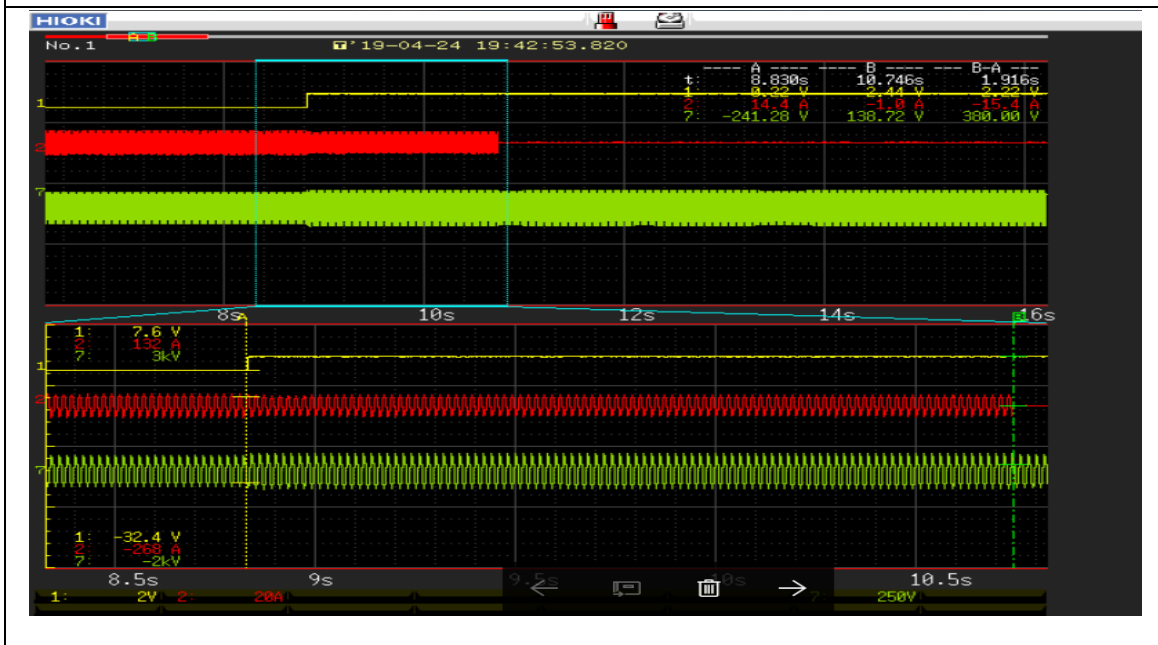

110 %Vn < V < 135 %Vn(setting at 282V)

Trip value

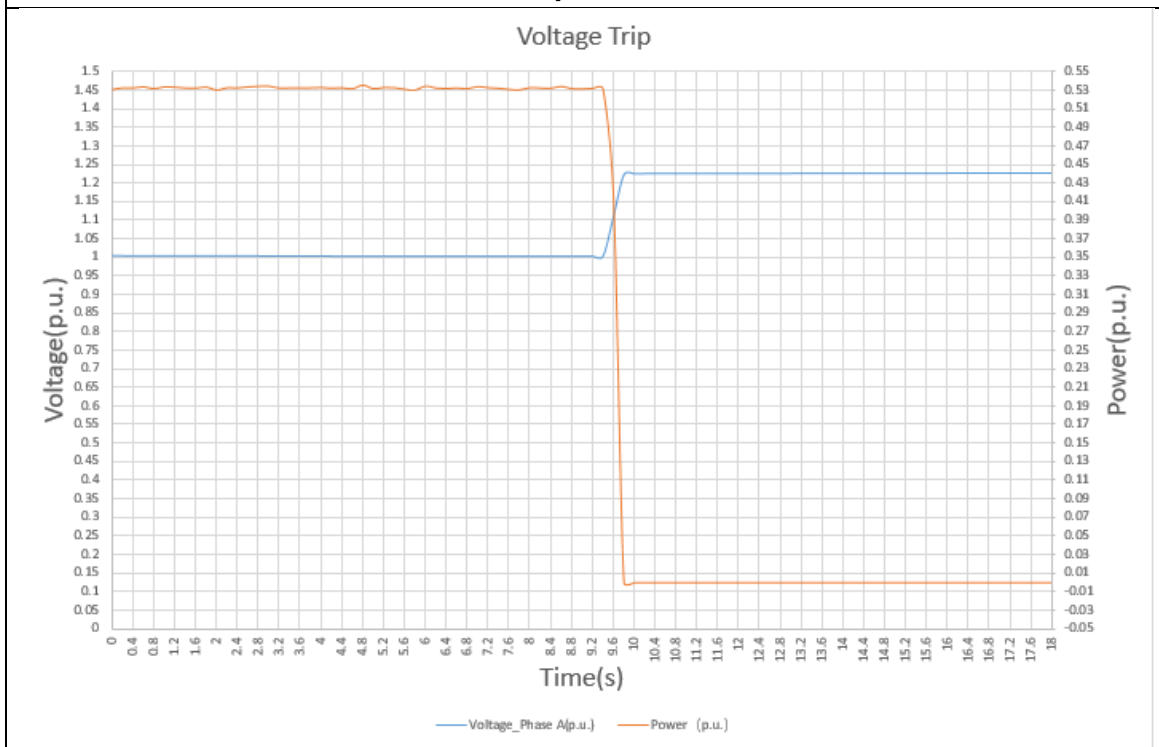

Disconnection Time

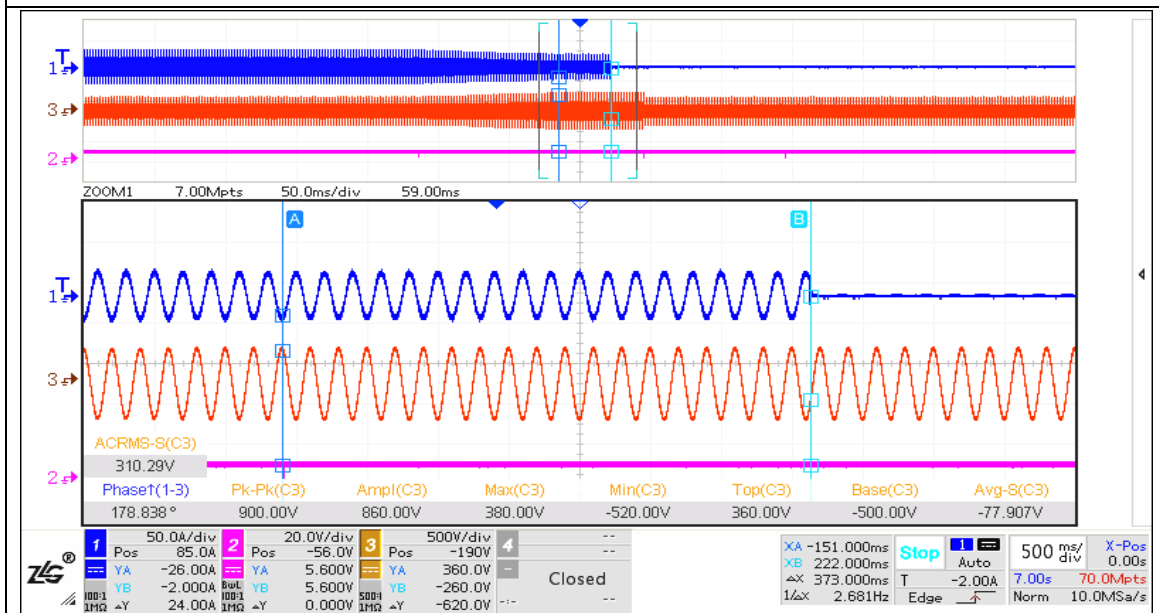

110 %Vn < V < 135 %Vn(setting at 309V)

Trip value

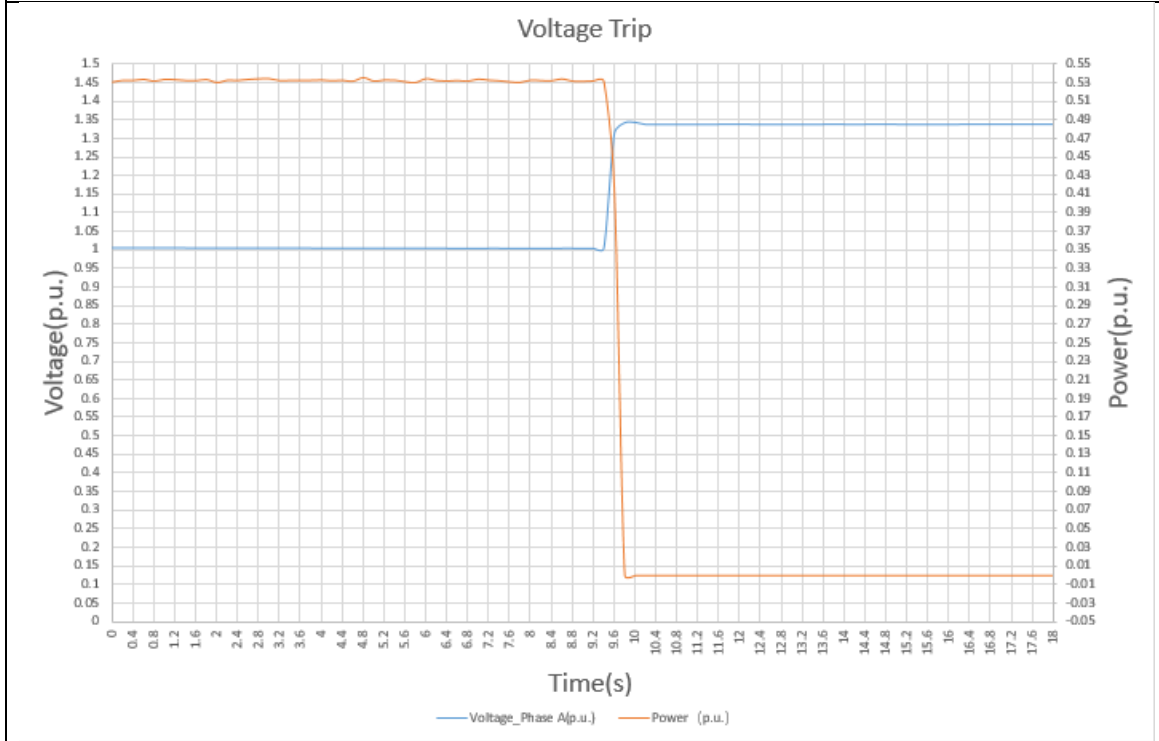

Disconnection Time

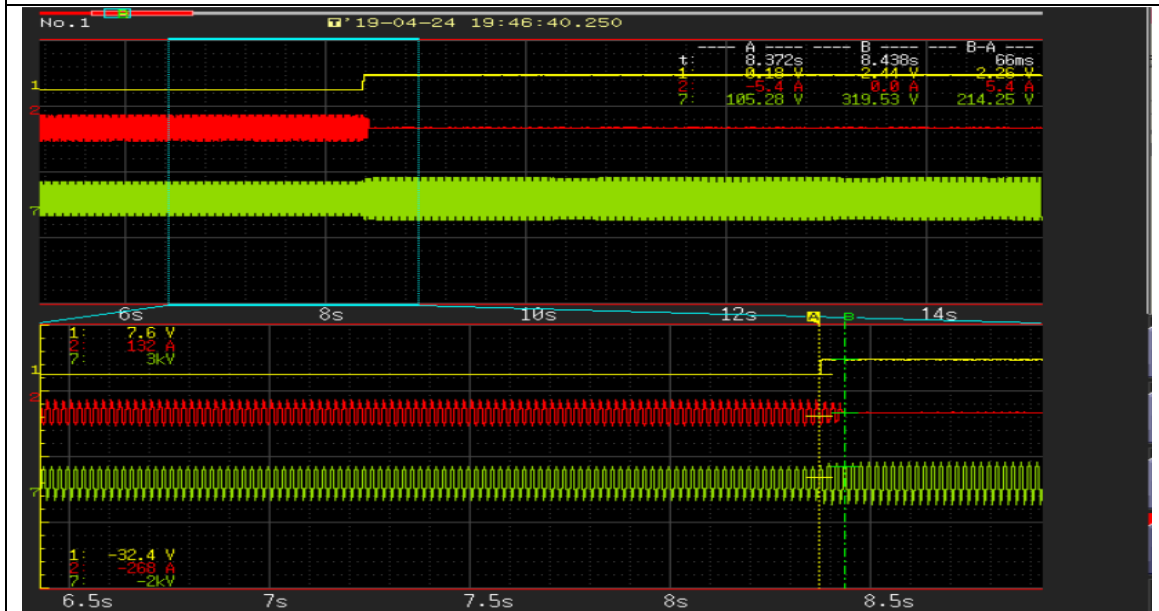

135%Vn ≤ V

Trip value

Voltage Trip

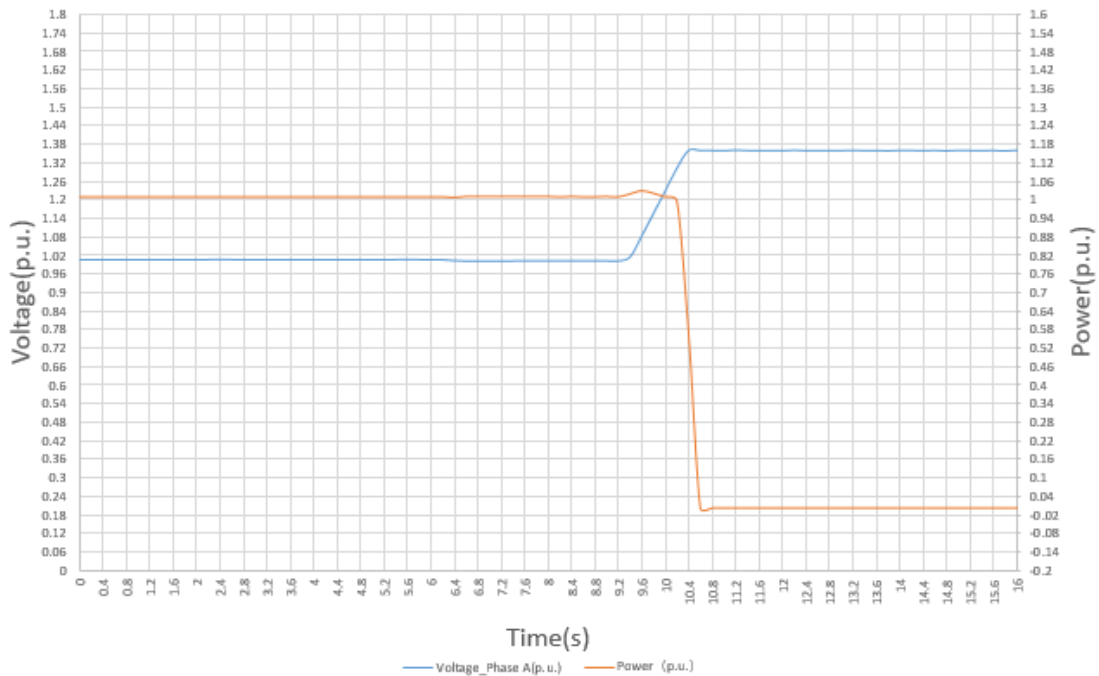

Disconnection Time

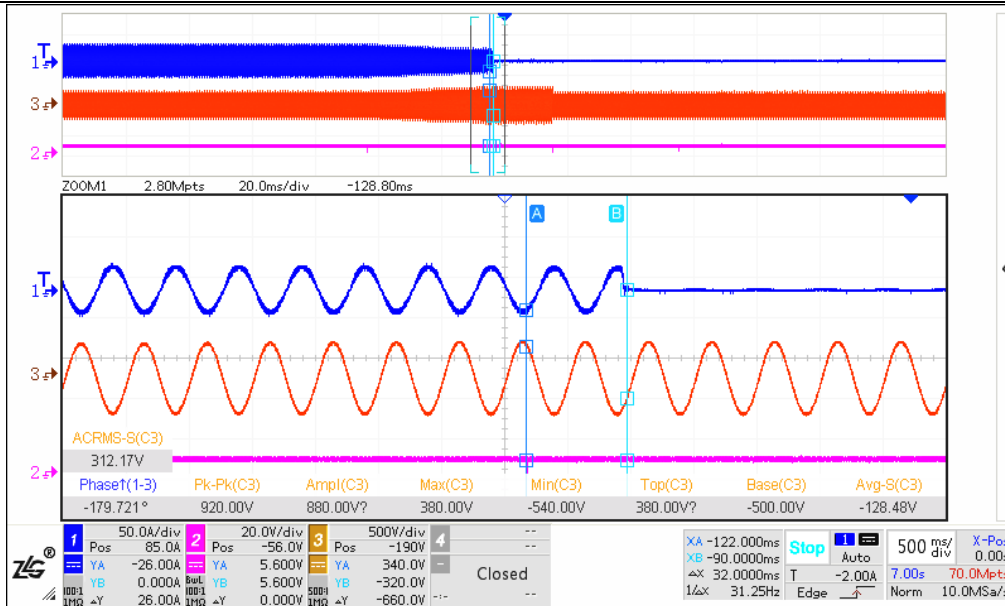

Over voltage reconnection

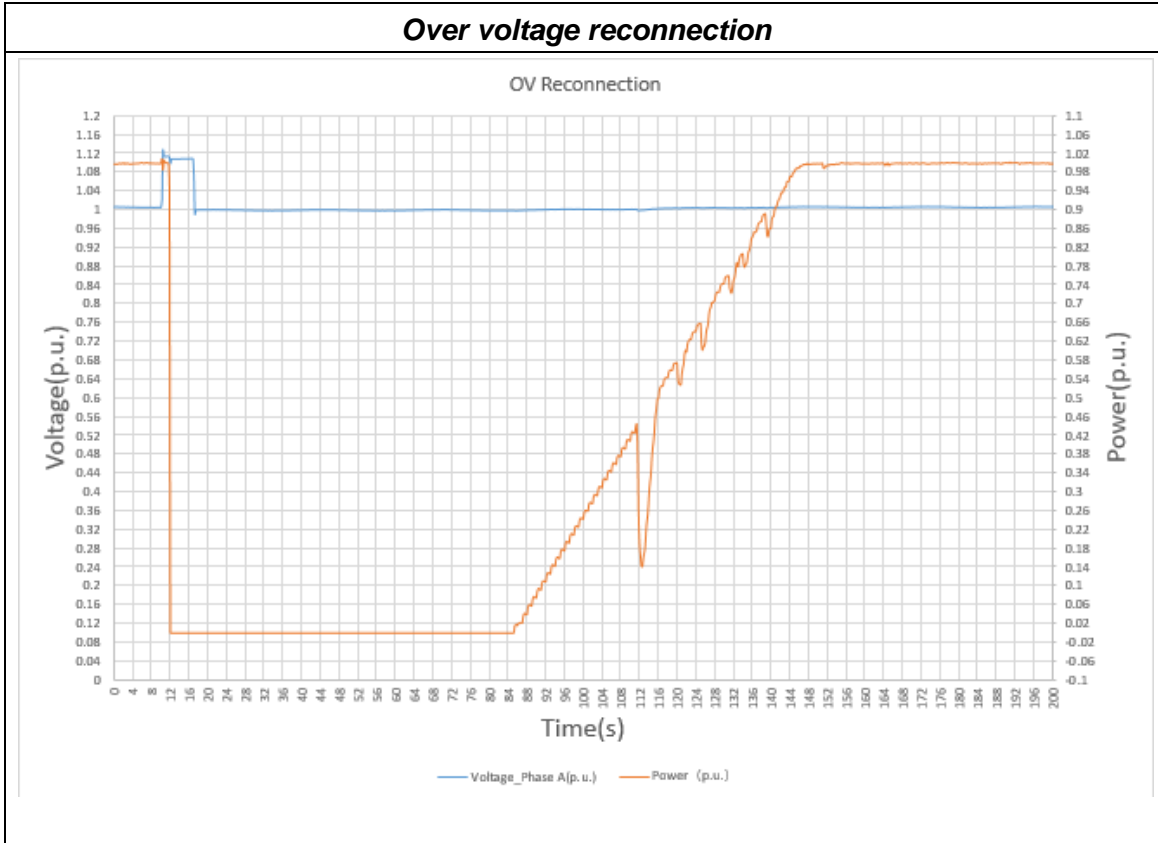

Over/under frequency trip settings and reconnection test

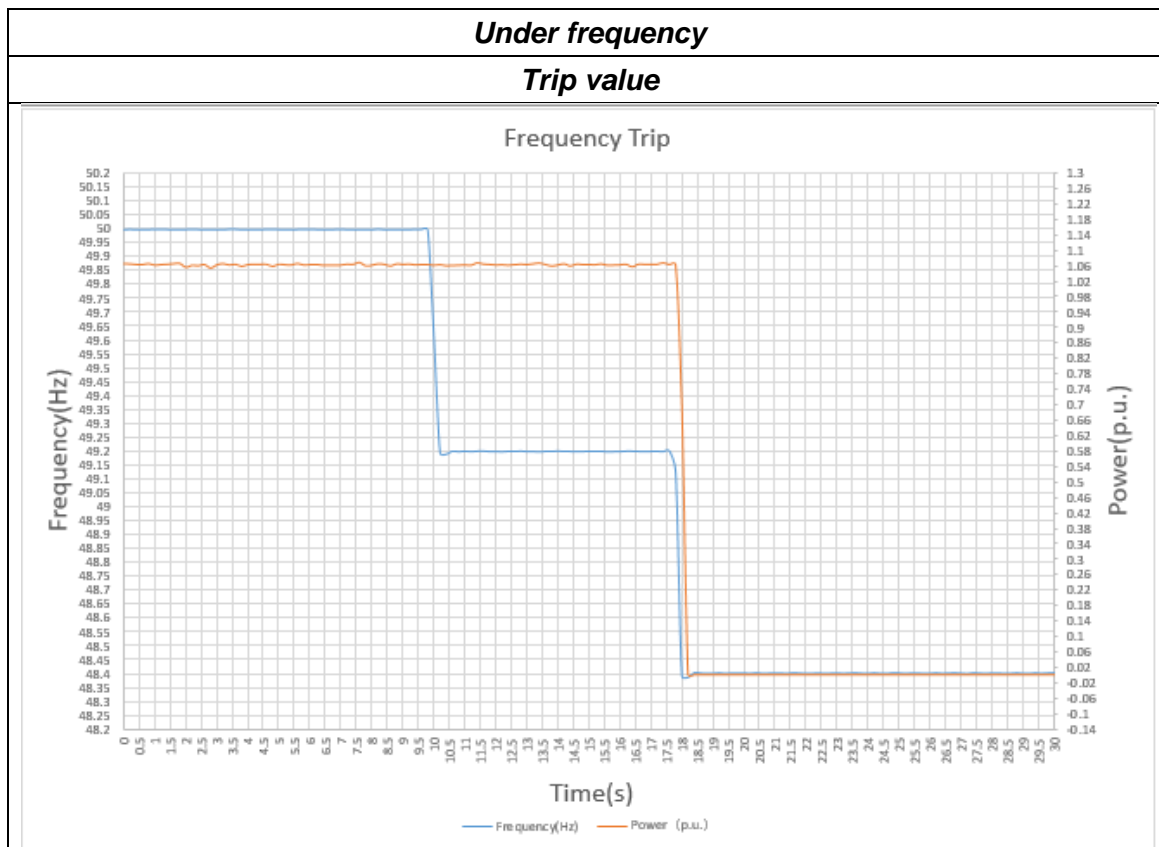

Disconnection time

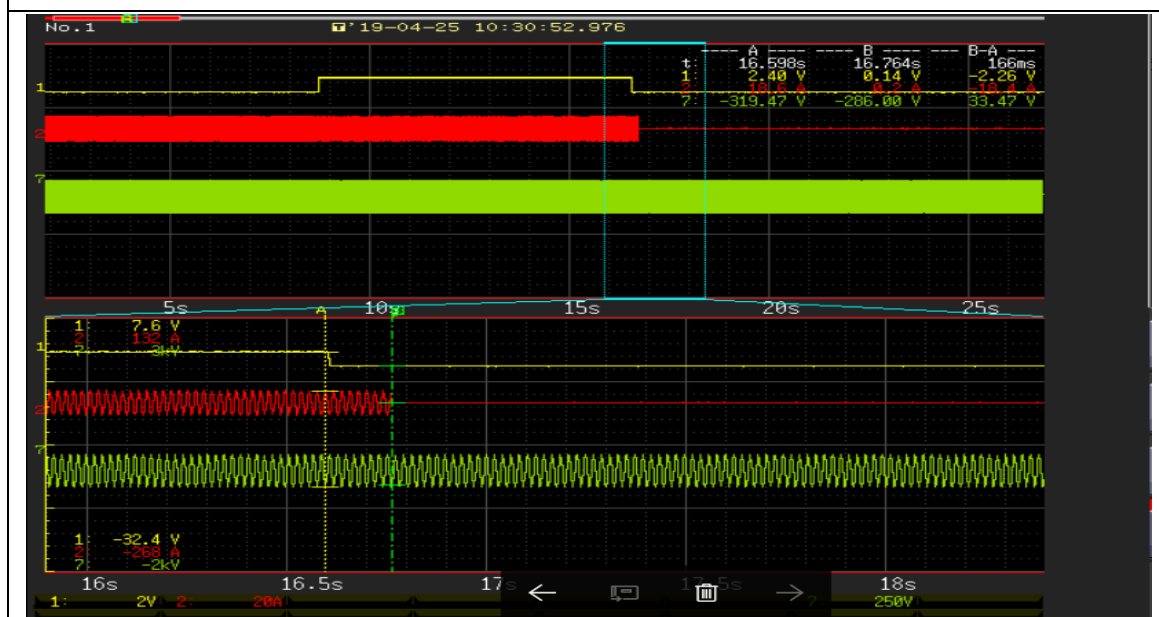

Under frequency reconnection

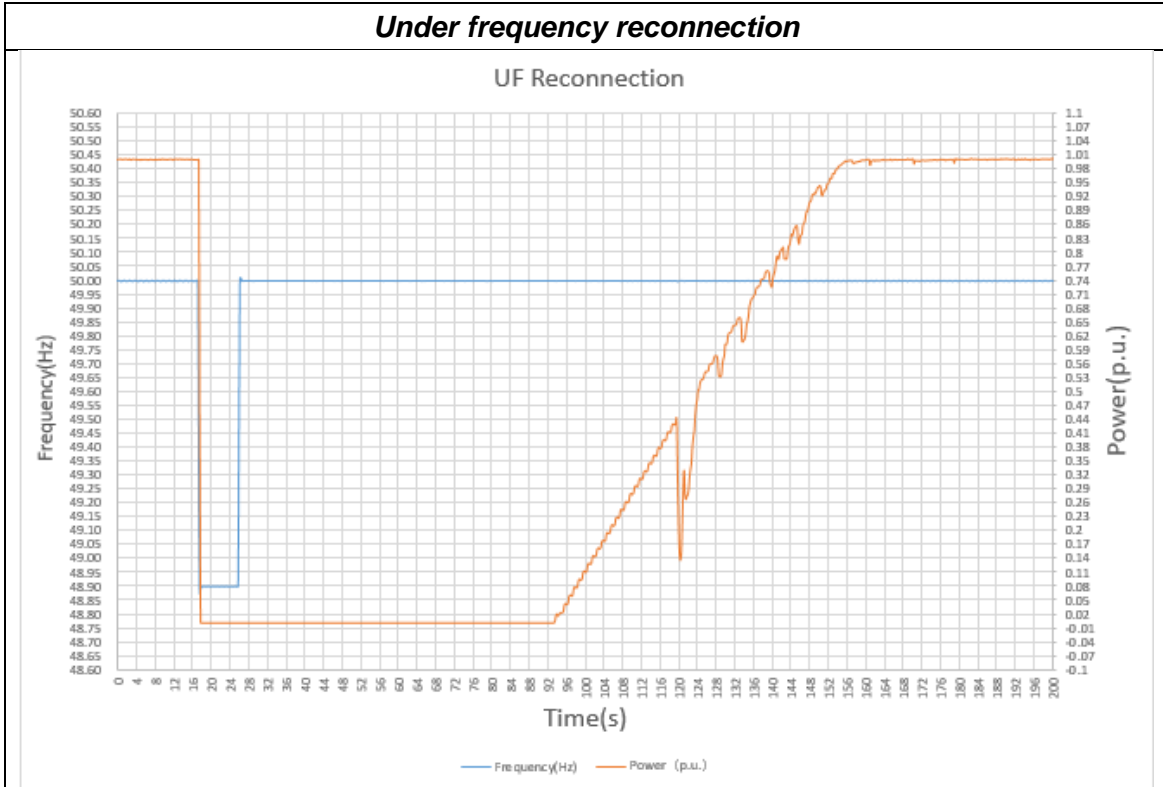

Disconnection time

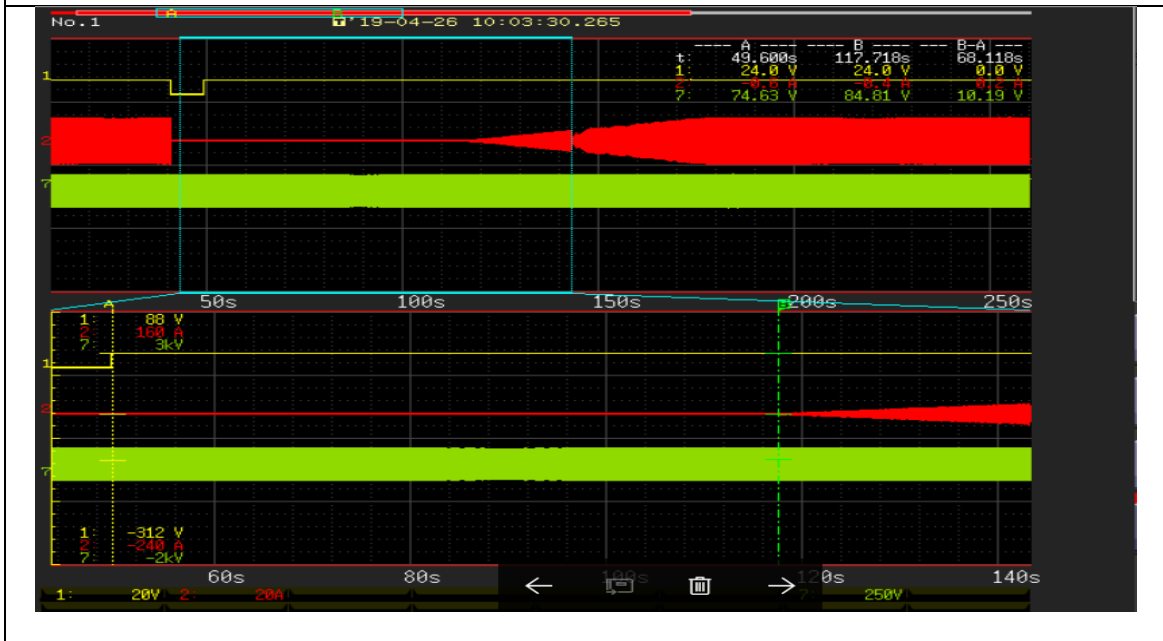

Over frequency

Trip value

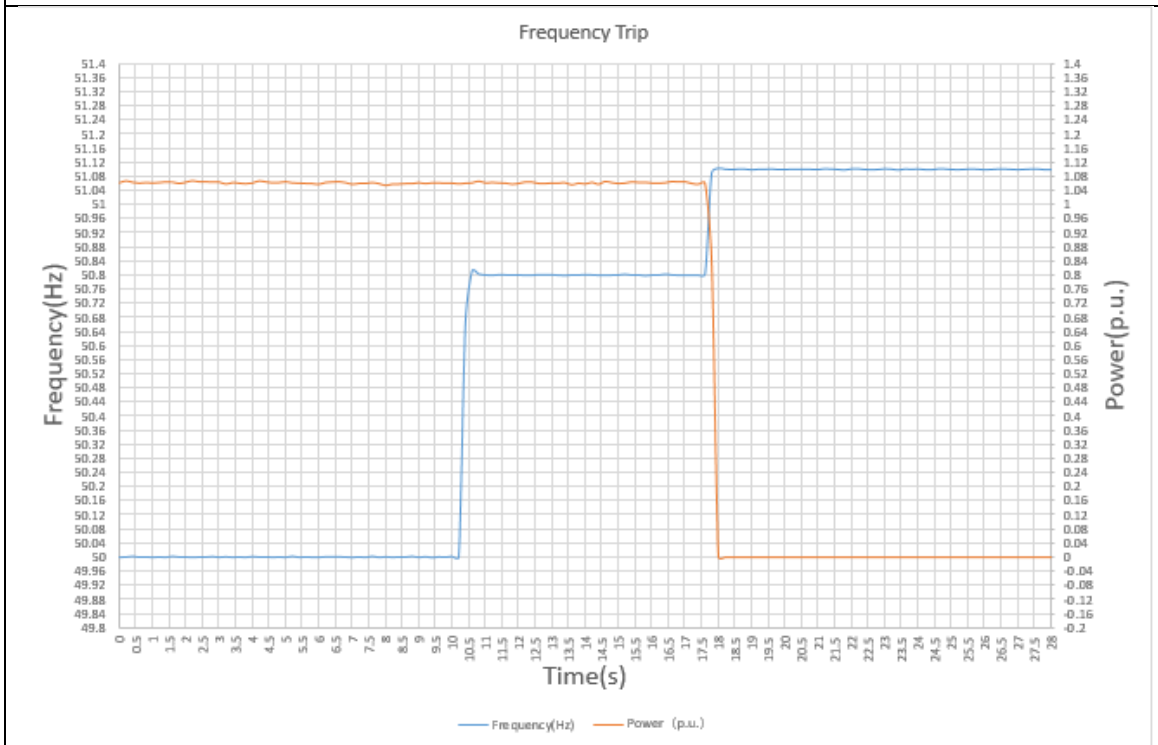

Disconnection time

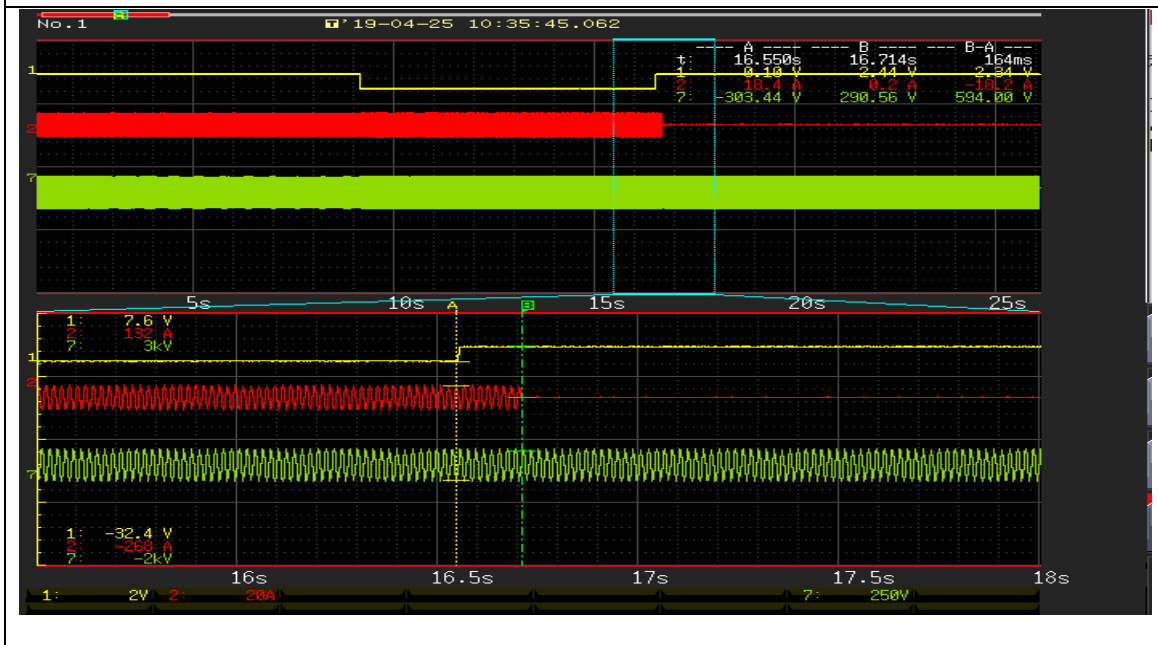

Over frequency reconnection

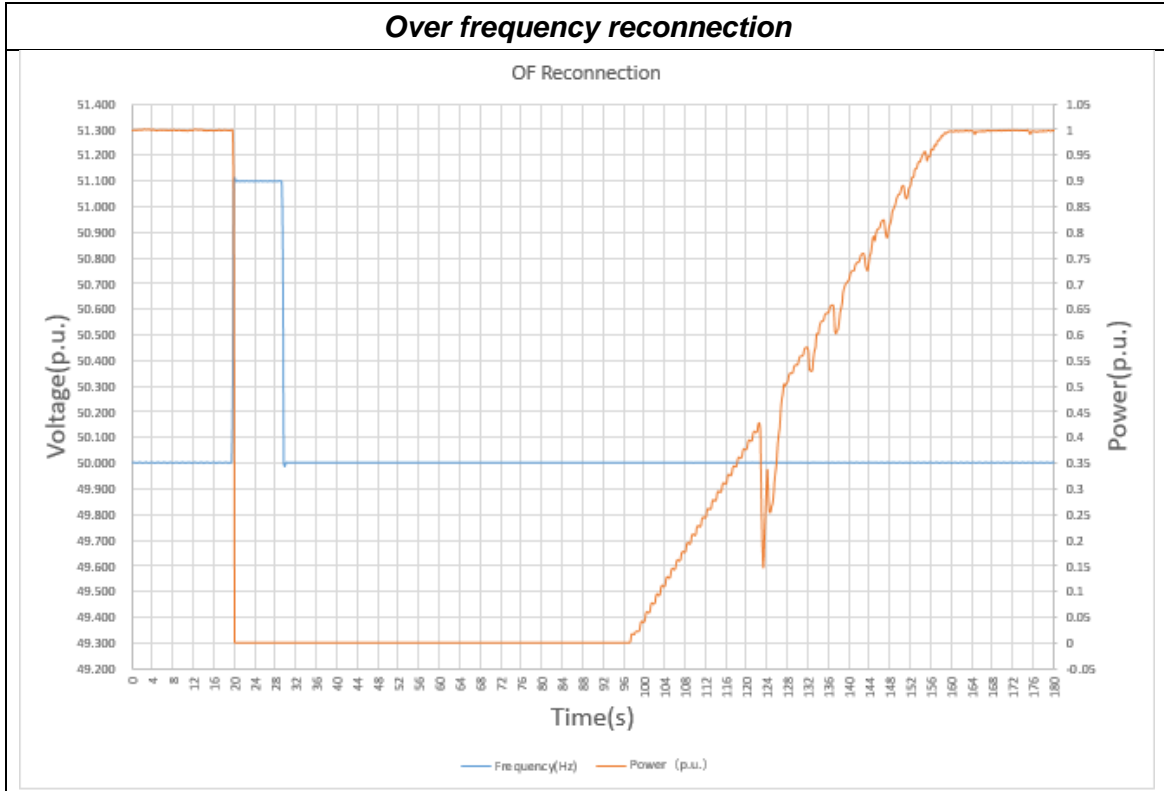

Disconnection time

